

LUMIEVO

The image features a dark blue background with vibrant, multi-colored light trails. These trails, in shades of red, cyan, and yellow, create a sense of motion and energy. Some trails are straight and parallel, while others are curved and overlapping, suggesting a complex, dynamic environment. The overall effect is reminiscent of a long-exposure photograph of light painting or a digital visualization of data flow.

2024

PRODUCT CONTENTS

LED BULKHEAD LIGHT

03

DUSAR 275
IK10 IP66



07

DUSAR 350
IK10 IP66



12

DUSAR SOLAR



13

DUSAR 10
small oval



14

DUSAR 16
large oval



16

DIONE
Square



LED FLOOD LIGHT

20

NEXUS
3CCT&3Watts



21

LUXOR
50w-400w



27

GAIA
500W



WEATHER PROOF LED BATTEN

28

ASTRO
3CCT&2Watts



30

ATLAS
IK10 AL



32

SELOS
IK10 PC



LED DOWNLIGHT

33

SPOTI



34

STELLAR



35

MARS



36

LUMIA



LED CEILING LIGHT

38

VIVID



LED STREET LIGHT

41

URANX



LED CANOPY LIGHT

46

SKYLA



Dusar

DSR275

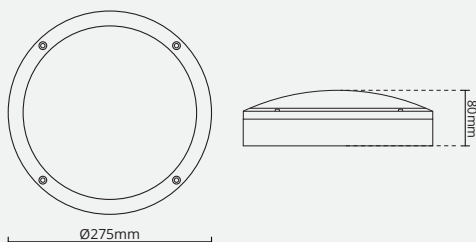

Weather and impact resistant, Selectable colour temperature, LED Bulkhead light

A round robust bulkhead light constructed with aluminium body and opal diffuser providing decorative solution for both residential and commercial applications.

Accessories
Optional TRIM



Photometric Diagram

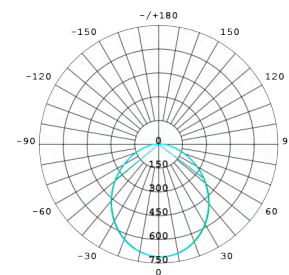

Unit: cd
 CO/180 120.0deg
 C90/270 120.0deg

KEY INFORMATION

Lumen Output	1050 / 2050 lm
Input Power	10W/20W(Watt-selectable)
Hole Cutout Size	N/A
Install	SURFACE MOUNT
Dimming Options	NON-DIMMABLE
Fitting Colour	BLACK/White
Warranty	5 yr
IP Rating	IP66
Ik Rating	IK10
IC Rating	N/A

PHOTOMETRIC

Efficacy	100-110 lm/W
LED	SMD
CCT	3000/4000/5000K (CCT-Selectable)
CRI	>80
Beam Angle	120°

ELECTRICAL

Driver	Integral
Supply Input	220-240V,50/60Hz
Power Factor	>0.9
Useful life @Ta 25°(L70)	50,000hrs

CONSTRUCTION

Housing	Aluminium
Optics	Polycarbonate Diffuser
Adjustable Angle	N/A
Fixings/Hardware	Mounting Screws
Connection Type	Terminal Block
Total Weight	1.3KG
Dimensions	275x80mm
Operating Ambient Temp.	-20 to 45°C
Electrical Classification	Class 1

Dusar Emergency

DSR275-EM

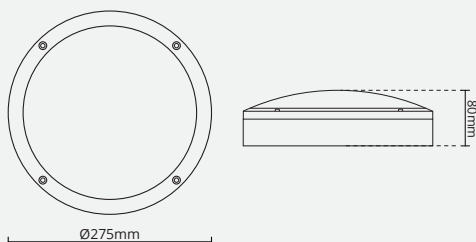

Weather and impact resistant, Selectable colour temperature, LED Bulkhead light

A round robust bulkhead light constructed with aluminium body and opal diffuser providing decorative solution for both residential and commercial applications.

Accessories
Optional TRIM



Photometric Diagram

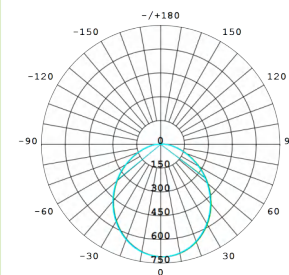

Unit: cd
 CO/180 120.0deg
 C90/270 120.0deg

KEY INFORMATION

Lumen Output	1050 / 2050 lm
Input Power	10W/20W(Watt-selectable)
Hole Cutout Size	N/A
Install	SURFACE MOUNT
Dimming Options	NON-DIMMABLE
Fitting Colour	BLACK/White
Warranty	5 yr
IP Rating	IP66
Ik Rating	IK10
IC Rating	N/A

PHOTOMETRIC

Efficacy	100-110 lm/W
LED	SMD
CCT	3000/4000/5000K (CCT-Selectable)
CRI	>80
Beam Angle	120°

ELECTRICAL

Driver	Integral
Supply Input	220-240V,50/60Hz
Power Factor	>0.9
Useful life @Ta 25°(L70)	50,000hrs
Emergency time	3hr

CONSTRUCTION

Housing	Aluminium
Optics	Polycarbonate Diffuser
Adjustable Angle	N/A
Fixings/Hardware	Mounting Screws
Connection Type	Terminal Block
Total Weight	1.3KG
Dimensions	275x80mm
Operating Ambient Temp.	-20 to 45°C
Electrical Classification	Class 1

Dusar Sensor

DSR275-MS

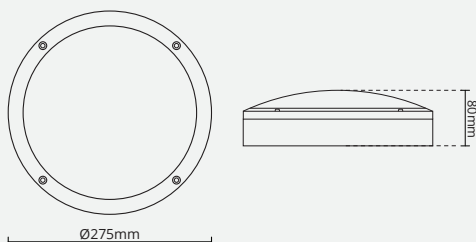

Weather and impact resistant, Selectable colour temperature, LED Bulkhead light

A round robust bulkhead light constructed with aluminium body and opal diffuser providing decorative solution for both residential and commercial applications.

Accessories
Optional TRIM



Photometric Diagram

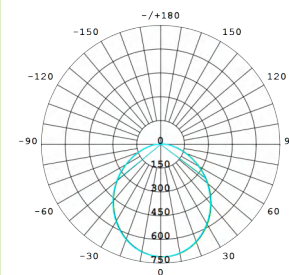

Unit: cd
 CO/180 120.0deg
 C90/270 120.0deg

KEY INFORMATION

Lumen Output	1050 / 2050 lm
Input Power	10W/20W(Watt-selectable)
Hole Cutout Size	N/A
Install	SURFACE MOUNT
Dimming Options	NON-DIMMABLE
Fitting Colour	BLACK/White
Warranty	5 yr
IP Rating	IP66
Ik Rating	IK10
IC Rating	N/A

PHOTOMETRIC

Efficacy	100-110 lm/W
LED	SMD
CCT	3000/4000/5000K (CCT-Selectable)
CRI	>80
Beam Angle	120°

ELECTRICAL

Driver	Integral
Supply Input	220-240V,50/60Hz
Power Factor	>0.9
Useful life @Ta 25°(L70)	50,000hrs
Sensor	Motion Detector

CONSTRUCTION

Housing	Aluminium
Optics	Polycarbonate Diffuser
Adjustable Angle	N/A
Fixings/Hardware	Mounting Screws
Connection Type	Terminal Block
Total Weight	1.3KG
Dimensions	275x80mm
Operating Ambient Temp.	-20 to 45°C
Electrical Classification	Class 1

lumieVO
LIGHT EVOLVING

Dusar Emergency +Sensor

DSR275-EM-MS

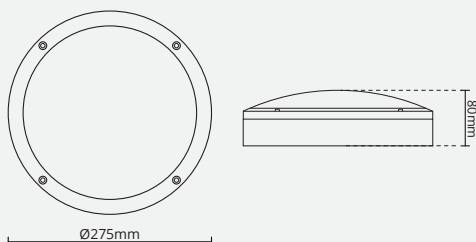

Weather and impact resistant, Selectable colour temperature, LED Bulkhead light

A round robust bulkhead light constructed with aluminium body and opal diffuser providing decorative solution for both residential and commercial applications.

Accessories
Optional TRIM



Photometric Diagram

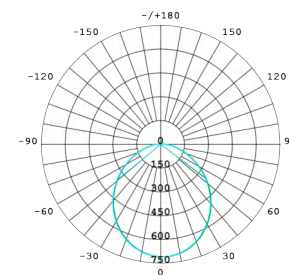

Unit: cd
CO/180 120.0deg
C90/270 120.0deg

KEY INFORMATION

Lumen Output	1050 / 2050 lm
Input Power	10W/20W(Watt-selectable)
Hole Cutout Size	N/A
Install	SURFACE MOUNT
Dimming Options	NON-DIMMABLE
Fitting Colour	BLACK/White
Warranty	5 yr
IP Rating	IP66
Ik Rating	IK10
IC Rating	N/A

PHOTOMETRIC

Efficacy	100-110 lm/W
LED	SMD
CCT	3000/4000/5000K (CCT-Selectable)
CRI	>80
Beam Angle	120°

ELECTRICAL

Driver	Integral
Supply Input	220-240V,50/60Hz
Power Factor	>0.9
Useful life @Ta 25°(L70)	50,000hrs
Emergency time	3hr
Sensor	Motion Detector

CONSTRUCTION

Housing	Aluminium
Optics	Polycarbonate Diffuser
Adjustable Angle	N/A
Fixings/Hardware	Mounting Screws
Connection Type	Terminal Block
Total Weight	1.3KG
Dimensions	275x80mm
Operating Ambient Temp.	-20 to 45°C
Electrical Classification	Class 1

Dusar

DSR350

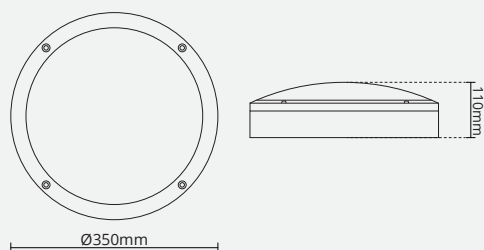

Weather and impact resistant, Selectable colour temperature, LED Bulkhead light

A large round robust bulkhead light constructed with aluminium body and opal diffuser providing decorative solution for both residential and commercial applications.

Accessories
Eyelid TRIM



Photometric Diagram

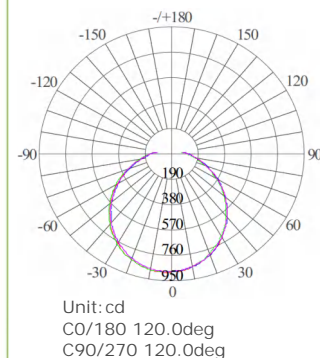

KEY INFORMATION

Lumen Output	3050 lm
Input Power	30W
Hole Cutout Size	N/A
Install	SURFACE MOUNT
Dimming Options	NON-DIMMABLE
Fitting Colour	BLACK/White
Warranty	5 yr
IP Rating	IP66
Ik Rating	IK10
IC Rating	N/A

PHOTOMETRIC

Efficacy	100-110 lm/W
LED	SMD
CCT	3000/4000/5000K (CCT-Selectable)
CRI	>80
Beam Angle	120°

ELECTRICAL

Driver	Integral
Supply Input	220-240V,50/60Hz
Power Factor	>0.9
Useful life @Ta 25°(L70)	50,000hrs

CONSTRUCTION

Housing	Aluminium
Optics	Polycarbonate Diffuser
Adjustable Angle	N/A
Fixings/Hardware	Mounting Screws
Connection Type	Terminal Block
Total Weight	2.6KG
Dimensions	350x110mm
Operating Ambient Temp.	-20 to 45°C
Electrical Classification	Class 1

Dusar Emergency

DSR350-EM

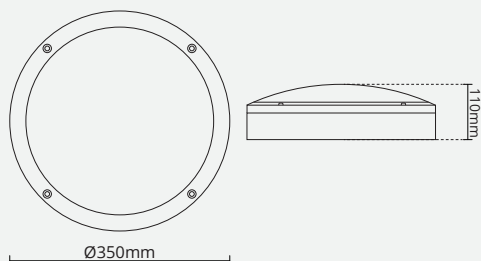

Weather and impact resistant, Selectable colour temperature, LED Bulkhead light

A large round robust bulkhead light constructed with aluminium body and opal diffuser providing decorative solution for both residential and commercial applications.

Accessories
Eyelid TRIM



Photometric Diagram

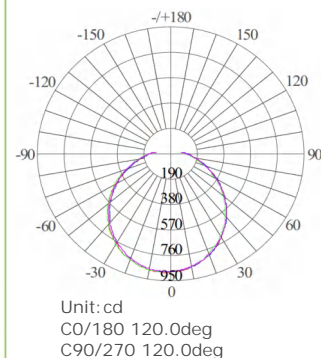

KEY INFORMATION

Lumen Output	3050 lm
Input Power	30W
Hole Cutout Size	N/A
Install	SURFACE MOUNT
Dimming Options	NON-DIMMABLE
Fitting Colour	BLACK/White
Warranty	5 yr
IP Rating	IP66
Ik Rating	IK10
IC Rating	N/A

PHOTOMETRIC

Efficacy	100-110 lm/W
LED	SMD
CCT	3000/4000/5000K (CCT-Selectable)
CRI	>80
Beam Angle	120°

ELECTRICAL

Driver	Integral
Supply Input	220-240V,50/60Hz
Power Factor	>0.9
Useful life @Ta 25°(L70)	50,000hrs
Emergency time	3hr

CONSTRUCTION

Housing	Aluminium
Optics	Polycarbonate Diffuser
Adjustable Angle	N/A
Fixings/Hardware	Mounting Screws
Connection Type	Terminal Block
Total Weight	2.6KG
Dimensions	350x110mm
Operating Ambient Temp.	-20 to 45°C
Electrical Classification	Class 1

Dusar Sensor

DSR350-MS

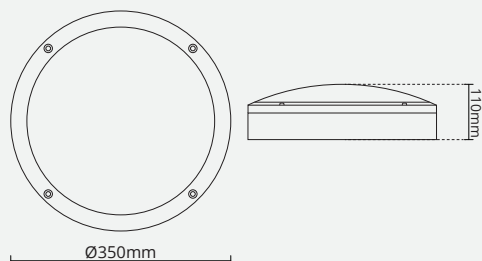

Weather and impact resistant, Selectable colour temperature, LED Bulkhead light

A large round robust bulkhead light constructed with aluminium body and opal diffuser providing decorative solution for both residential and commercial applications.

Accessories
Eyelid TRIM



Photometric Diagram

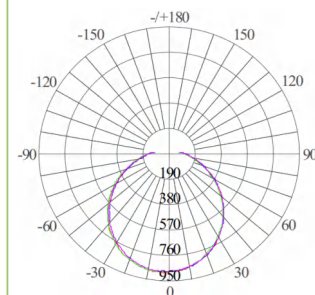

Unit: cd
 CO/180 120.0deg
 C90/270 120.0deg

KEY INFORMATION

Lumen Output	3050 lm
Input Power	30W
Hole Cutout Size	N/A
Install	SURFACE MOUNT
Dimming Options	NON-DIMMABLE
Fitting Colour	BLACK/White
Warranty	5 yr
IP Rating	IP66
Ik Rating	IK10
IC Rating	N/A

PHOTOMETRIC

Efficacy	100-110 lm/W
LED	SMD
CCT	3000/4000/5000K (CCT-Selectable)
CRI	>80
Beam Angle	120°

ELECTRICAL

Driver	Integral
Supply Input	220-240V,50/60Hz
Power Factor	>0.9
Useful life @Ta 25°(L70)	50,000hrs
Sensor	Motion Detector

CONSTRUCTION

Housing	Aluminium
Optics	Polycarbonate Diffuser
Adjustable Angle	N/A
Fixings/Hardware	Mounting Screws
Connection Type	Terminal Block
Total Weight	2.6KG
Dimensions	350x110mm
Operating Ambient Temp.	-20 to 45°C
Electrical Classification	Class 1

Dusar Emergency

DSR350-EM-MS +Sensor

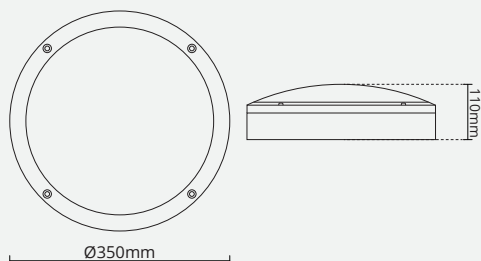

Weather and impact resistant, Selectable colour temperature, LED Bulkhead light

A large round robust bulkhead light constructed with aluminium body and opal diffuser providing decorative solution for both residential and commercial applications.

Accessories
Eyelid TRIM



Photometric Diagram

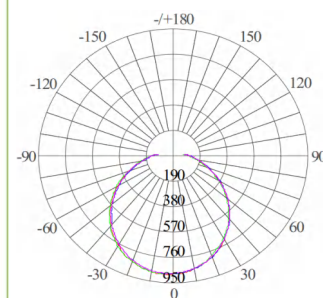

Unit: cd
 CO/180 120.0deg
 C90/270 120.0deg

KEY INFORMATION

Lumen Output	3050 lm
Input Power	30W
Hole Cutout Size	N/A
Install	SURFACE MOUNT
Dimming Options	NON-DIMMABLE
Fitting Colour	BLACK/White
Warranty	5 yr
IP Rating	IP66
Ik Rating	IK10
IC Rating	N/A

PHOTOMETRIC

Efficacy	100-110 lm/W
LED	SMD
CCT	3000/4000/5000K (CCT-Selectable)
CRI	>80
Beam Angle	120°

ELECTRICAL

Driver	Integral
Supply Input	220-240V,50/60Hz
Power Factor	>0.9
Useful life @Ta 25°(L70)	50,000hrs
Emergency time	3hr
Sensor	Motion Detector

CONSTRUCTION

Housing	Aluminium
Optics	Polycarbonate Diffuser
Adjustable Angle	N/A
Fixings/Hardware	Mounting Screws
Connection Type	Terminal Block
Total Weight	2.6KG
Dimensions	350x110mm
Operating Ambient Temp.	-20 to 45°C
Electrical Classification	Class 1

Dusar Anti-Injection

DSR-AJ

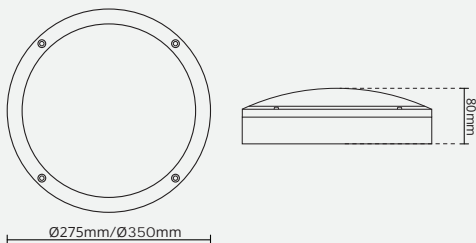

Our specially developed Deep Blue / Border UV Lamp. This product is being commonly used to deter intravenous drug users from operating in public spaces. The colour prevents easy location of veins on the skin. Can also be used to illuminate fluorescence through certain types of Glass that inhibit UVA frequencies.

A round robust bulkhead light constructed with aluminium body and opal diffuser providing decorative solution for Public Spaces, washrooms, bathrooms of public places.

Accessories
Optional TRIM

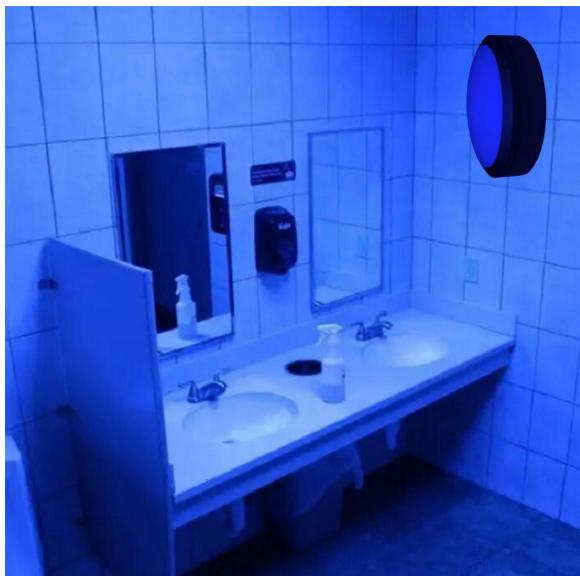

Photometric Diagram

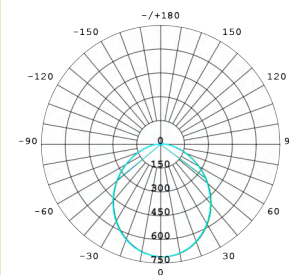

Unit: cd
 CO/180 120.0deg
 C90/270 120.0deg

KEY INFORMATION

Lumen Output	1600 / 2400 lm
Input Power	20W/30W
Hole Cutout Size	N/A
Install	SURFACE MOUNT
Dimming Options	NON-DIMMABLE
Fitting Colour	BLACK/White
Warranty	5 yr
IP Rating	IP66
Ik Rating	IK10
IC Rating	N/A

PHOTOMETRIC

Efficacy	80 lm/W
LED	SMD
CCT	Deep Blue Light
CRI	>80
Beam Angle	120°

ELECTRICAL

Driver	Integral
Supply Input	220-240V,50/60Hz
Power Factor	>0.9
Useful life @Ta 25°(L70)	50,000hrs

CONSTRUCTION

Housing	Aluminium
Optics	Polycarbonate Diffuser
Adjustable Angle	N/A
Fixings/Hardware	Mounting Screws
Connection Type	Terminal Block
Total Weight	1.3KG/2.6KG
Dimensions	275x80mm / φ350x110mm
Operating Ambient Temp.	-20 to 45°C
Electrical Classification	Class 1

Dusar Solar

DSR-SL

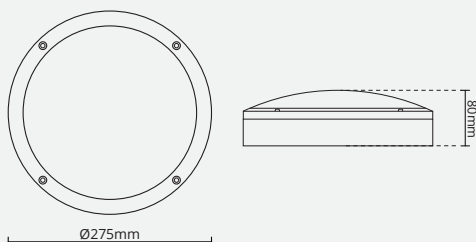

Weather and impact resistant, Durable and long lasting, Solar LED Bulkhead light

A round robust bulkhead light constructed with aluminium body and opal diffuser providing decorative solution for both residential and commercial applications. Automatic night-time operation, Smart power battery detection – LED brightness will be automatically reduced to prolong battery life

Accessories
Optional TRIM



Photometric Diagram

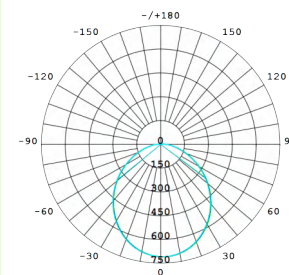

Unit: cd
 CO/180 120.0deg
 C90/270 120.0deg

KEY INFORMATION

Lumen Output	2400 lm
Input Power	20W
Hole Cutout Size	N/A
Install	SURFACE MOUNT
Dimming Options	DIMMABLE
Fitting Colour	BLACK/White
Warranty	3 yr
IP Rating	IP66
Ik Rating	IK10
IC Rating	N/A

PHOTOMETRIC

Efficacy	120 lm/W
LED	SMD
CCT	6000K
CRI	>80
Beam Angle	120°

ELECTRICAL

Solar panel	15W 6V
Battery	3.7V 12AH, 44.4wh
Charging time	~8 Hours (from 0-100%)
Operation time	Dusk to dawn
Sensor	Microwave (up-to 10m), 180°
Sensor Function	30% standby, 100% when motion

CONSTRUCTION

Housing	Aluminium
Optics	Polycarbonate Diffuser
Adjustable Angle	N/A
Fixings/Hardware	Mounting Screws
Solar panel Dimension	350x350x20mm
Total Weight	2.3KG
Light Dimension	275x80mm
Operating Ambient Temp.	-20 to 45°C
Cable to the solar panel	Aluminium

Warning & Reminding

1. This product includes rechargeable batteries which must be adequately charged under sun light before use.
2. Before install the light, please press on/off button inside the light to get it activated at the first use.
3. The light is equipped with an internal battery pack, which is replaceable.
4. Build-in intelligent IC with over-charge, over-discharge, over-temperature protection.
5. Please do not dispose the battery with household garbage to avoid explosion.
6. Non-professionals please do not disassemble the lamp.

Dusar

DSO10

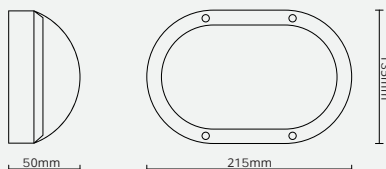

Weather and impact resistant, Selectable colour temperature, LED Bulkhead light

A small oval robust bulkhead light constructed with aluminium body and opal diffuser providing decorative solution for both residential and commercial applications.

Accessories
Optional TRIM



Photometric Diagram

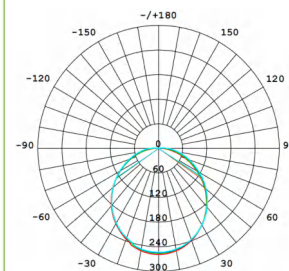

Unit: cd
 CO/180 120.0deg
 C90/270 120.0deg

KEY INFORMATION

Lumen Output	1050lm
Input Power	10W
Hole Cutout Size	N/A
Install	SURFACE MOUNT
Dimming Options	NON-DIMMABLE
Fitting Colour	BLACK/White
Warranty	5 yr
IP Rating	IP66
Ik Rating	IK10
IC Rating	N/A

PHOTOMETRIC

Efficacy	100-110 lm/W
LED	SMD
CCT	3000/4000/5000K (CCT-Selectable)
CRI	>80
Beam Angle	120°

ELECTRICAL

Driver	Integral
Supply Input	220-240V,50/60Hz
Power Factor	>0.9
Useful life @Ta 25°(L70)	50,000hrs

CONSTRUCTION

Housing	Aluminium
Optics	Polycarbonate Diffuser
Adjustable Angle	N/A
Fixings/Hardware	Mounting Screws
Connection Type	Terminal Block
Total Weight	1.0 KG
Dimensions	215x135x50mm
Operating Ambient Temp.	-20 to 45°C
Electrical Classification	Class 1

Dusar

DSO16

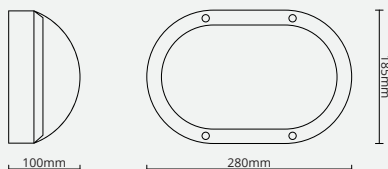

Weather and impact resistant, Selectable colour temperature, LED Bulkhead light

A large oval robust bulkhead light constructed with aluminium body and opal diffuser providing decorative solution for both residential and commercial applications.

Accessories
Optional TRIM



Photometric Diagram

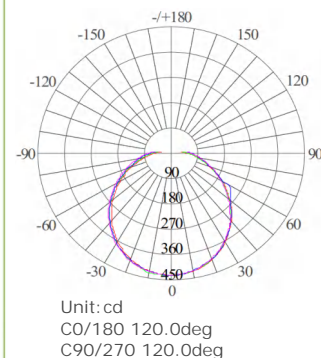

KEY INFORMATION

Lumen Output	1650 lm
Input Power	16W
Hole Cutout Size	N/A
Install	SURFACE MOUNT
Dimming Options	NON-DIMMABLE
Fitting Colour	BLACK/White
Warranty	5 yr
IP Rating	IP66
Ik Rating	IK10
IC Rating	N/A

PHOTOMETRIC

Efficacy	100-110 lm/W
LED	SMD
CCT	3000/4000/5000K (CCT-Selectable)
CRI	>80
Beam Angle	120°

ELECTRICAL

Driver	Integral
Supply Input	220-240V,50/60Hz
Power Factor	>0.9
Useful life @Ta 25°(L70)	50,000hrs

CONSTRUCTION

Housing	Aluminium
Optics	Polycarbonate Diffuser
Adjustable Angle	N/A
Fixings/Hardware	Mounting Screws
Connection Type	Terminal Block
Total Weight	1.3 KG
Dimensions	280x185x100mm
Operating Ambient Temp.	-20 to 45°C
Electrical Classification	Class 1

Dusar Sensor

DSO16-MS

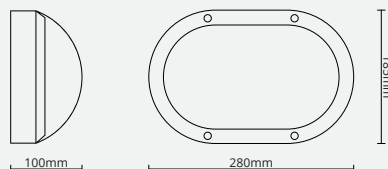

Weather and impact resistant, Selectable colour temperature, LED Bulkhead light

A large oval robust bulkhead light constructed with aluminium body and opal diffuser providing decorative solution for both residential and commercial applications.

Accessories
Optional TRIM



Photometric Diagram

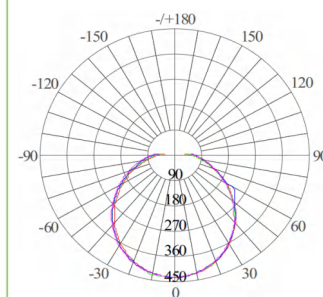

Unit: cd
 CO/180 120.0deg
 C90/270 120.0deg

KEY INFORMATION

Lumen Output	1650 lm
Input Power	16W
Hole Cutout Size	N/A
Install	SURFACE MOUNT
Dimming Options	NON-DIMMABLE
Fitting Colour	BLACK/White
Warranty	5 yr
IP Rating	IP66
Ik Rating	IK10
IC Rating	N/A

PHOTOMETRIC

Efficacy	100-110 lm/W
LED	SMD
CCT	3000/4000/5000K (CCT-Selectable)
CRI	>80
Beam Angle	120°

ELECTRICAL

Driver	Integral
Supply Input	220-240V,50/60Hz
Power Factor	>0.9
Useful life @Ta 25°(L70)	50,000hrs
Sensor	Motion Detector

CONSTRUCTION

Housing	Aluminium
Optics	Polycarbonate Diffuser
Adjustable Angle	N/A
Fixings/Hardware	Mounting Screws
Connection Type	Terminal Block
Total Weight	1.3KG
Dimensions	280x185x100mm
Operating Ambient Temp.	-20 to 45°C
Electrical Classification	Class 1

DIONE

DIN270

Weather and impact resistant, Selectable colour temperature, LED Bulkhead light

A square robust bulkhead light constructed with aluminium body and opal diffuser providing decorative solution for both residential and commercial applications.

Accessories
Optional TRIM



Photometric Diagram

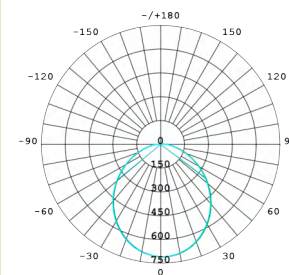

Unit: cd
 CO/180 120.0deg
 C90/270 120.0deg

KEY INFORMATION

Lumen Output	1050 / 2050 lm
Input Power	10W/20W(Watt-selectable)
Hole Cutout Size	N/A
Install	SURFACE MOUNT
Dimming Options	NON-DIMMABLE
Fitting Colour	BLACK/White
Warranty	5 yr
IP Rating	IP66
Ik Rating	IK10
IC Rating	N/A

PHOTOMETRIC

Efficacy	100-110 lm/W
LED	SMD
CCT	3000/4000/5000K (CCT-Selectable)
CRI	>80
Beam Angle	120°

ELECTRICAL

Driver	Integral
Supply Input	220-240V,50/60Hz
Power Factor	>0.9
Useful life @Ta 25°(L70)	50,000hrs

CONSTRUCTION

Housing	Aluminium
Optics	Polycarbonate Diffuser
Adjustable Angle	N/A
Fixings/Hardware	Mounting Screws
Connection Type	Terminal Block
Total Weight	2.0KG
Dimensions	270x270x85mm
Operating Ambient Temp.	-20 to 45°C
Electrical Classification	Class 1

DIONE Emergency

DIN270-EM

Weather and impact resistant, Selectable colour temperature, LED Bulkhead light

A square robust bulkhead light constructed with aluminium body and opal diffuser providing decorative solution for both residential and commercial applications.

Accessories
Optional TRIM



Photometric Diagram

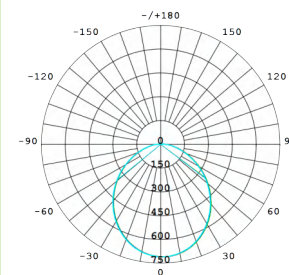

Unit: cd
 CO/180 120.0deg
 C90/270 120.0deg

KEY INFORMATION

Lumen Output	1050 / 2050 lm
Input Power	10W/20W(Watt-selectable)
Hole Cutout Size	N/A
Install	SURFACE MOUNT
Dimming Options	NON-DIMMABLE
Fitting Colour	BLACK/White
Warranty	5 yr
IP Rating	IP66
Ik Rating	IK10
IC Rating	N/A

PHOTOMETRIC

Efficacy	100-110 lm/W
LED	SMD
CCT	3000/4000/5000K (CCT-Selectable)
CRI	>80
Beam Angle	120°

ELECTRICAL

Driver	Integral
Supply Input	220-240V,50/60Hz
Power Factor	>0.9
Useful life @Ta 25°(L70)	50,000hrs
Emergency time	3hr

CONSTRUCTION

Housing	Aluminium
Optics	Polycarbonate Diffuser
Adjustable Angle	N/A
Fixings/Hardware	Mounting Screws
Connection Type	Terminal Block
Total Weight	2.0KG
Dimensions	270x270x85mm
Operating Ambient Temp.	-20 to 45°C
Electrical Classification	Class 1



DIONE Sensor

DIN270-MS

Weather and impact resistant, Selectable colour temperature, LED Bulkhead light

A square robust bulkhead light constructed with aluminium body and opal diffuser providing decorative solution for both residential and commercial applications.

Accessories
Optional TRIM



Photometric Diagram

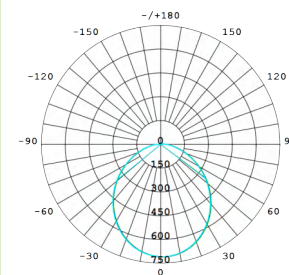

Unit: cd
 CO/180 120.0deg
 C90/270 120.0deg

KEY INFORMATION

Lumen Output	1050 / 2050 lm
Input Power	10W/20W(Watt-selectable)
Hole Cutout Size	N/A
Install	SURFACE MOUNT
Dimming Options	NON-DIMMABLE
Fitting Colour	BLACK/White
Warranty	5 yr
IP Rating	IP66
Ik Rating	IK10
IC Rating	N/A

PHOTOMETRIC

Efficacy	100-110 lm/W
LED	SMD
CCT	3000/4000/5000K (CCT-Selectable)
CRI	>80
Beam Angle	120°

ELECTRICAL

Driver	Integral
Supply Input	220-240V,50/60Hz
Power Factor	>0.9
Useful life @Ta 25°(L70)	50,000hrs
Sensor	Motion Detector

CONSTRUCTION

Housing	Aluminium
Optics	Polycarbonate Diffuser
Adjustable Angle	N/A
Fixings/Hardware	Mounting Screws
Connection Type	Terminal Block
Total Weight	2.0KG
Dimensions	270x270x85mm
Operating Ambient Temp.	-20 to 45°C
Electrical Classification	Class 1

DIONE Emergency

DIN270-EM-MS +Sensor

Weather and impact resistant, Selectable colour temperature, LED Bulkhead light

A square robust bulkhead light constructed with aluminium body and opal diffuser providing decorative solution for both residential and commercial applications.

Accessories
Optional TRIM



Photometric Diagram

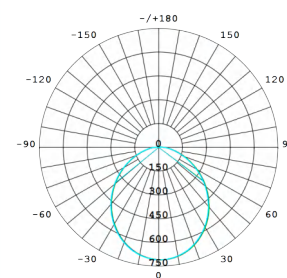

Unit: cd
 CO/180 120.0deg
 C90/270 120.0deg

KEY INFORMATION

Lumen Output	1050 / 2050 lm
Input Power	10W/20W(Watt-selectable)
Hole Cutout Size	N/A
Install	SURFACE MOUNT
Dimming Options	NON-DIMMABLE
Fitting Colour	BLACK/White
Warranty	5 yr
IP Rating	IP66
Ik Rating	IK10
IC Rating	N/A

PHOTOMETRIC

Efficacy	100-110 lm/W
LED	SMD
CCT	3000/4000/5000K (CCT-Selectable)
CRI	>80
Beam Angle	120°

ELECTRICAL

Driver	Integral
Supply Input	220-240V,50/60Hz
Power Factor	>0.9
Useful life @Ta 25°(L70)	50,000hrs
Emergency time	3hr
Sensor	Motion Detector

CONSTRUCTION

Housing	Aluminium
Optics	Polycarbonate Diffuser
Adjustable Angle	N/A
Fixings/Hardware	Mounting Screws
Connection Type	Terminal Block
Total Weight	2.0KG
Dimensions	270x270x85mm
Operating Ambient Temp.	-20 to 45°C
Electrical Classification	Class 1

Nexus

NES100

3-CCT(3K/4K/5K) and
 3-Watts (30W/60W/100W)
 in one fitting

Ultra-efficient
 offset bracket ,
 super slim body,
 LEDFlood light

Perfect for any exterior space
 from residential small
 wattage designs through to
 high performance commercial
 applications

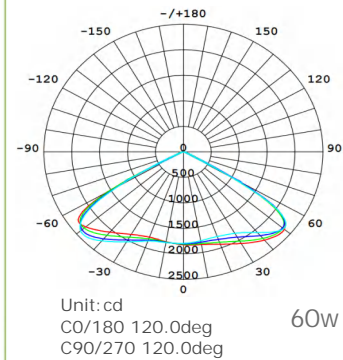
 Photometric
 Diagram

KEY INFORMATION

Lumen Output	3,000-10,000lm
Input Power	30W/60W/100W
Hole Cutout Size	N/A
Install	N/A
Dimming Options	NON-DIMMABLE
Fitting Colour	BLACK
Warranty	3 yr
IP Rating	IP66
Ik Rating	IK08
IC Rating	N/A

PHOTOMETRIC

Efficacy	100 lm/W
LED	SMD
CCT	3000/4000/5000K
CRI	>80
Beam Angle	120°

ELECTRICAL

Driver	Integral
Supply Input	200-240V,50/60Hz
Power Factor	>0.9
Useful life @Ta 25°(L70)	50,000hrs
Emergency time	N/A
Sensor	N/A

CONSTRUCTION

Housing	Aluminium
Optics	Tempered Glass
Adjustable Angle	180°
Fixings/Hardware	Mounting Screws
Connection Type	N/A
Total Weight	2.0KG
Dimensions	250 x167 x42 mm
Operating Ambient Temp.	-20 to 45°C
Electrical Classification	Class 1

Luxor

LXR50

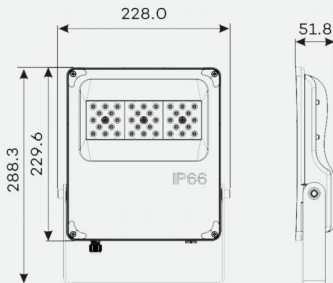

Ultra-efficient
offset bracket ,
super slim body,
LED Flood light

Perfect for any exterior space
from residential small
wattage designs through to
high performance commercial
applications

Accessories
Optional Twin Bracket



Photometric
Diagram

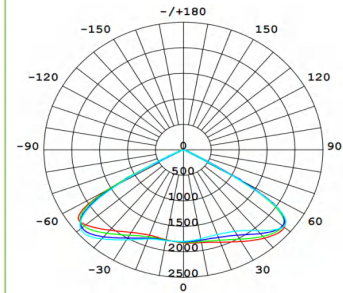

Unit: cd
C0/180 120.0deg
C90/270 120.0deg

KEY INFORMATION

Lumen Output	6500 lm
Input Power	50W
Hole Cutout Size	N/A
Install	N/A
Dimming Options	NON-DIMMABLE
Fitting Colour	BLACK
Warranty	5 yr
IP Rating	IP66
Ik Rating	IK08
IC Rating	N/A

PHOTOMETRIC

Efficacy	130 lm/W
LED	SMD
CCT	3000/4000/5000K
CRI	>80
Beam Angle	90°/120°/Asymmetric

ELECTRICAL

Driver	Integral
Supply Input	90-305V,50/60Hz
Power Factor	>0.95
Useful life @Ta 25°(L70)	50,000hrs
Emergency time	N/A
Sensor	N/A

CONSTRUCTION

Housing	Aluminium
Optics	Tempered Glass
Adjustable Angle	180°
Fixings/Hardware	Mounting Screws
Connection Type	N/A
Total Weight	3.0KG
Dimensions	288.3x228.0x51.8mm
Operating Ambient Temp.	-20 to 45°C
Electrical Classification	Class 1

Luxor

LXR100

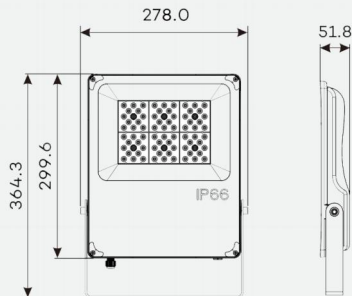

Ultra-efficient
offset bracket ,
super slim body,
LED Flood light

Perfect for any exterior space
from residential small
wattage designs through to
high performance commercial
applications

Accessories
Optional Twin Bracket



Photometric Diagram

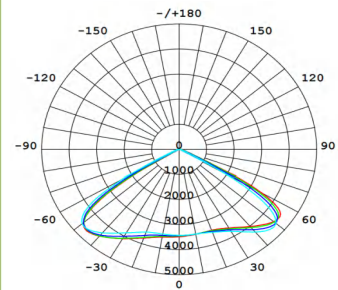

Unit: cd
 CO/180 120.0deg
 C90/270 120.0deg

KEY INFORMATION

Lumen Output	13,000 lm
Input Power	100W
Hole Cutout Size	N/A
Install	N/A
Dimming Options	NON-DIMMABLE
Fitting Colour	BLACK
Warranty	5 yr
IP Rating	IP66
Ik Rating	IK08
IC Rating	N/A

PHOTOMETRIC

Efficacy	130 lm/W
LED	SMD
CCT	3000/4000/5000K
CRI	>80
Beam Angle	90°/120°/Asymmetric

ELECTRICAL

Driver	Integral
Supply Input	90-305V,50/60Hz
Power Factor	>0.95
Useful life @Ta 25°(L70)	50,000hrs
Emergency time	N/A
Sensor	N/A

CONSTRUCTION

Housing	Aluminium
Optics	Tempered Glass
Adjustable Angle	180°
Fixings/Hardware	Mounting Screws
Connection Type	N/A
Total Weight	5.2KG
Dimensions	364.3x278.0x51.8mm
Operating Ambient Temp.	-20 to 45°C
Electrical Classification	Class 1

Luxor

LXR150

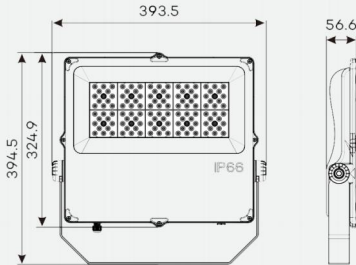

Ultra-efficient
offset bracket ,
super slim body,
LED Flood light

Perfect for any exterior space
from residential small
wattage designs through to
high performance commercial
applications

Accessories
Optional Twin Bracket



Photometric
Diagram

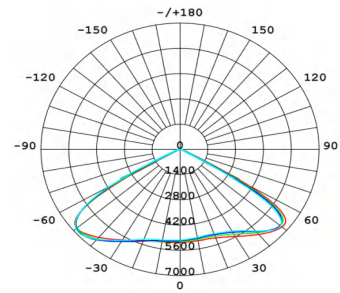

Unit: cd
C0/180 120.0deg
C90/270 120.0deg

KEY INFORMATION

Lumen Output	19,500 lm
Input Power	150W
Hole Cutout Size	N/A
Install	N/A
Dimming Options	NON-DIMMABLE
Fitting Colour	BLACK
Warranty	5 yr
IP Rating	IP66
Ik Rating	IK08
IC Rating	N/A

PHOTOMETRIC

Efficacy	130 lm/W
LED	SMD
CCT	3000/4000/5000K
CRI	>80
Beam Angle	90°/120°/Asymmetric

ELECTRICAL

Driver	Integral
Supply Input	90-305V,50/60Hz
Power Factor	>0.95
Useful life @Ta 25°(L70)	50,000hrs
Emergency time	N/A
Sensor	N/A

CONSTRUCTION

Housing	Aluminium
Optics	Tempered Glass
Adjustable Angle	180°
Fixings/Hardware	Mounting Screws
Connection Type	N/A
Total Weight	6.6KG
Dimensions	394.5x393.5x56.6mm
Operating Ambient Temp.	-20 to 45°C
Electrical Classification	Class 1

Luxor

LXR200

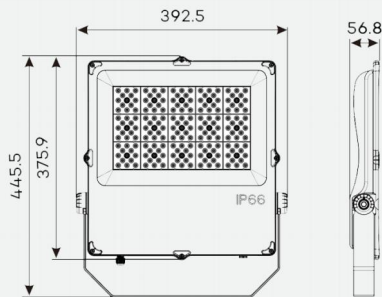

Ultra-efficient
offset bracket ,
super slim body,
LED Flood light

Perfect for any exterior space
from residential small
wattage designs through to
high performance commercial
applications

Accessories
Optional Twin Bracket



Photometric
Diagram

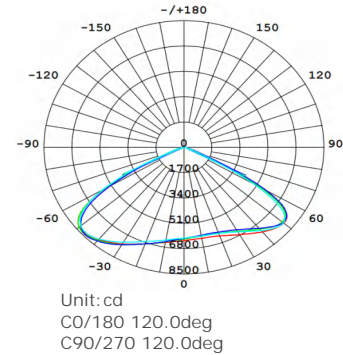

KEY INFORMATION

Lumen Output	26,000 lm
Input Power	200W
Hole Cutout Size	N/A
Install	N/A
Dimming Options	NON-DIMMABLE
Fitting Colour	BLACK
Warranty	5 yr
IP Rating	IP66
Ik Rating	IK08
IC Rating	N/A

PHOTOMETRIC

Efficacy	130 lm/W
LED	SMD
CCT	3000/4000/5000K
CRI	>80
Beam Angle	90°/120°/Asymmetric

ELECTRICAL

Driver	Integral
Supply Input	90-305V,50/60Hz
Power Factor	>0.95
Useful life @Ta 25°(L70)	50,000hrs
Emergency time	N/A
Sensor	N/A

CONSTRUCTION

Housing	Aluminium
Optics	Tempered Glass
Adjustable Angle	180°
Fixings/Hardware	Mounting Screws
Connection Type	N/A
Total Weight	7.3 KG
Dimensions	445.5x392.5x56.8mm
Operating Ambient Temp.	-20 to 45°C
Electrical Classification	Class 1

Luxor

LXR300

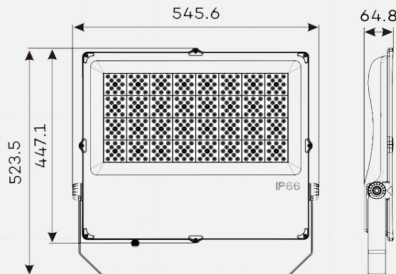

Ultra-efficient
offset bracket ,
super slim body,
LED Flood light

Perfect for any exterior space
from residential small
wattage designs through to
high performance commercial
applications

Accessories
Optional Twin Bracket



Photometric Diagram Unit: cd

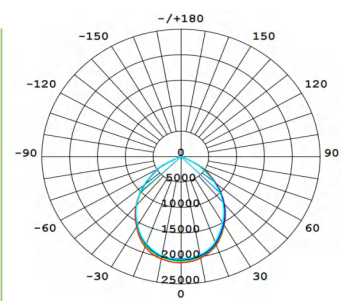

C0/180 90.0deg C90/270 90.0deg

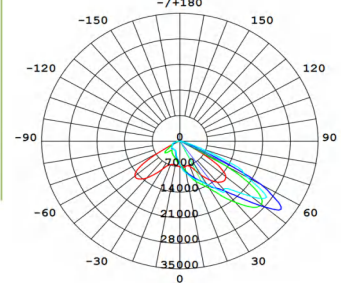

Asymmetric

C0/180 123.4deg C90/270 36.5deg

KEY INFORMATION

Lumen Output	39,000 lm
Input Power	300W
Hole Cutout Size	N/A
Install	N/A
Dimming Options	NON-DIMMABLE
Fitting Colour	BLACK
Warranty	5 yr
IP Rating	IP66
Ik Rating	IK08
IC Rating	N/A

PHOTOMETRIC

Efficacy	130 lm/W
LED	SMD
CCT	3000/4000/5000K
CRI	>80
Beam Angle	90°/120°/Asymmetric

ELECTRICAL

Driver	Integral
Supply Input	90-305V,50/60Hz
Power Factor	>0.95
Useful life @Ta 25°(L70)	50,000hrs
Emergency time	N/A
Sensor	N/A

CONSTRUCTION

Housing	Aluminium
Optics	Tempered Glass
Adjustable Angle	180°
Fixings/Hardware	Mounting Screws
Connection Type	N/A
Total Weight	11.5 KG
Dimensions	523.5x545.6x64.8mm
Operating Ambient Temp.	-20 to 45°C
Electrical Classification	Class 1

Luxor

LXR400

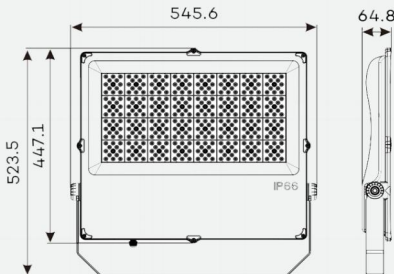

Ultra-efficient
offset bracket ,
super slim body,
LED Flood light

Perfect for any exterior space
from residential small
wattage designs through to
high performance commercial
applications

Accessories
Optional Twin Bracket



Photometric Diagram Unit:cd

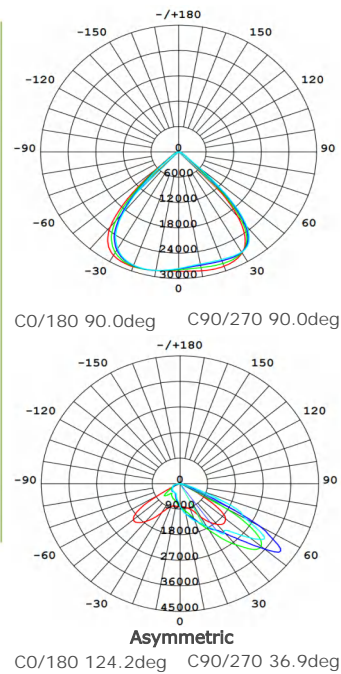

KEY INFORMATION

Lumen Output	52,000 lm
Input Power	400W
Hole Cutout Size	N/A
Install	N/A
Dimming Options	NON-DIMMABLE
Fitting Colour	BLACK
Warranty	5 yr
IP Rating	IP66
Ik Rating	IK08
IC Rating	N/A

PHOTOMETRIC

Efficacy	130 lm/W
LED	SMD
CCT	3000/4000/5000K
CRI	>80
Beam Angle	90°/120°/Asymmetric

ELECTRICAL

Driver	Integral
Supply Input	90-305V,50/60Hz
Power Factor	>0.95
Useful life @Ta 25°(L70)	50,000hrs
Emergency time	N/A
Sensor	N/A

CONSTRUCTION

Housing	Aluminium
Optics	Tempered Glass
Adjustable Angle	180°
Fixings/Hardware	Mounting Screws
Connection Type	N/A
Total Weight	12.0 KG
Dimensions	523.5x545.6x64.8mm
Operating Ambient Temp.	-20 to 45°C
Electrical Classification	Class 1

lumieVO
LIGHT EVOLVING

Gaix

Gax500

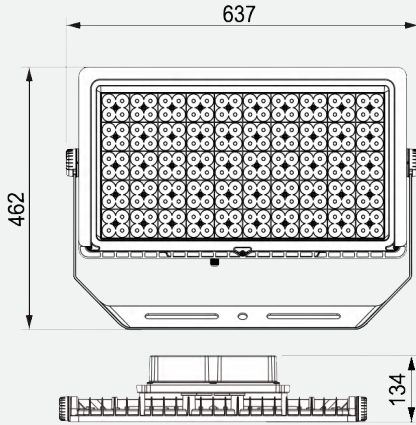

Symmetrical or asymmetrical, Robust Gaix LED Flood light

Ideal for harsh conditions, with superior housing made of LM6 grade die-cast aluminium, in addition to a chromated and powder-coated black finish

Accessories

Optional Hood/Twin Bracket



Photometric Diagram Unit:cd

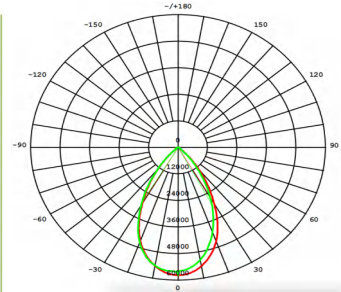

C0/180 60.0deg C90/270 60.0deg

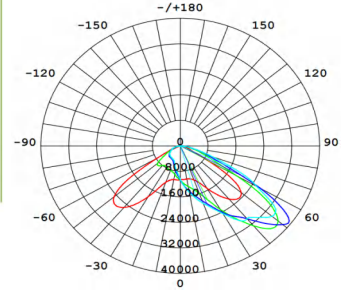

Asymmetric

C0/180 124.6deg C90/270 49.3deg

KEY INFORMATION

Lumen Output	70,000 lm
Input Power	500W
Hole Cutout Size	N/A
Install	N/A
Dimming Options	NON-DIMMABLE
Fitting Colour	BLACK
Warranty	5 yr
IP Rating	IP66
Ik Rating	IK08
IC Rating	N/A

PHOTOMETRIC

Efficacy	140 lm/W
LED	SMD
CCT	3000/4000/5000K
CRI	>80
Beam Angle	60°/Asymmetric

ELECTRICAL

Driver	Integral
Supply Input	90-305V,50/60Hz
Power Factor	>0.95
Useful life @Ta 25°(L70)	50,000hrs
Emergency time	N/A
Sensor	N/A

CONSTRUCTION

Housing	Aluminium
Optics	Tempered Glass
Adjustable Angle	180°
Fixings/Hardware	Mounting Screws
Connection Type	N/A
Total Weight	12.0 KG
Dimensions	531x128x377mm
Operating Ambient Temp.	-20 to 45°C
Electrical Classification	Class 1

Astro

Asr600

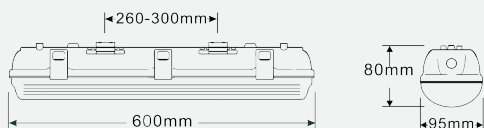

Photometric Diagram

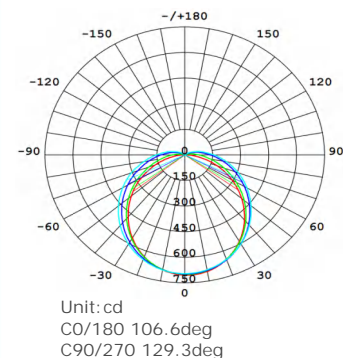

The ability to select your preferred lumen output/wattage within one light fitting.

These are the perfect option when simple functionality is required. Rear and side entry options for easy linking and conduit entry. Combined diffuser and gear tray lead to exceptionally fast fit off. Vandal resistant latches can be secured to stop any tampering. 3 Colour selection with a fixed power driver.

KEY INFORMATION

Lumen Output	13,00 lm/26,00 lm
Input Power	10W/20W (Watt-select)
Hole Cutout Size	N/A
Install	N/A
Dimming Options	NON-DIMMABLE
Fitting Colour	Grey base
Warranty	5 yr
IP Rating	IP65
Ik Rating	IK08
IC Rating	N/A

PHOTOMETRIC

Efficacy	130 lm/W
LED	SMD
CCT	3000/4000/5000K(CCT-Select)
CRI	>80
Beam Angle	120°

ELECTRICAL

Driver	Integral
Supply Input	200-240V,50/60Hz
Power Factor	>0.95
Useful life @Ta 25°(L70)	50,000hrs
Emergency time	180mins(Emergency Option)
Sensor	Setting via Remote(Sensor Option)

CONSTRUCTION

Housing	Polycarbonate
Optics	Polycarbonate
Adjustable Angle	N/A
Fixings/Hardware	Mounting Screws
Connection Type	N/A
Total Weight	0.82 KG
Dimensions	600x95x80mm
Operating Ambient Temp.	-20 to 45°C
Electrical Classification	Class 1

Astro

Asr1200

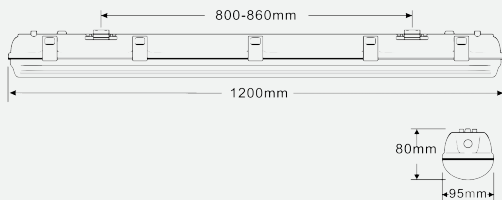

The ability to select your preferred lumen output/wattage within one light fitting.

These are the perfect option when simple functionality is required. Rear and side entry options for easy linking and conduit entry. Combined diffuser and gear tray lead to exceptionally fast fit off. Vandal resistant latches can be secured to stop any tampering. 3 Colour selection with a fixed power driver.



Photometric Diagram

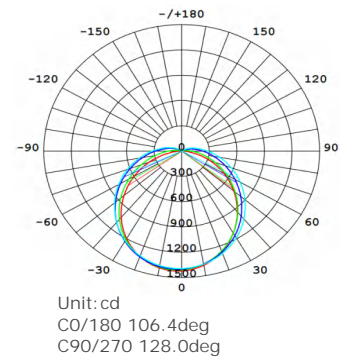

KEY INFORMATION

Lumen Output	26,00 lm/52,00 lm
Input Power	20W/40W (Watt-select)
Hole Cutout Size	N/A
Install	N/A
Dimming Options	NON-DIMMABLE
Fitting Colour	Grey base
Warranty	5 yr
IP Rating	IP65
Ik Rating	IK08
IC Rating	N/A

PHOTOMETRIC

Efficacy	130 lm/W
LED	SMD
CCT	3000/4000/5000K(CCT-Select)
CRI	>80
Beam Angle	120°

ELECTRICAL

Driver	Integral
Supply Input	200-240V,50/60Hz
Power Factor	>0.95
Useful life @Ta 25°(L70)	50,000hrs
Emergency time	180mins(Emergency Option)
Sensor	Setting via Remote(Sensor Option)

CONSTRUCTION

Housing	Polycarbonate
Optics	Polycarbonate
Adjustable Angle	N/A
Fixings/Hardware	Mounting Screws
Connection Type	N/A
Total Weight	1.28 KG
Dimensions	1200x95x80mm
Operating Ambient Temp.	-20 to 45°C
Electrical Classification	Class 1

Atlas

Ats600

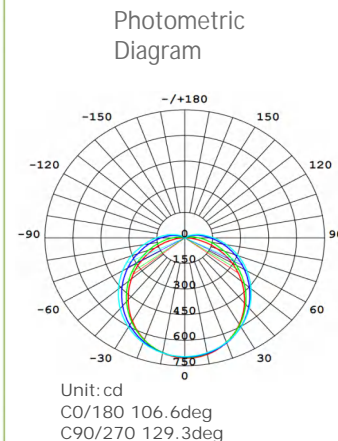
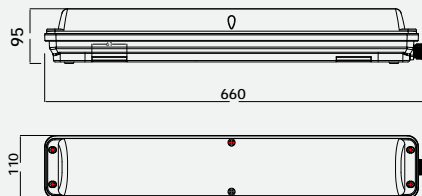

4-Watts Select
3-CCT Select

a Strong IK10 robust weatherproof batten, built for tough conditions.

The control gear has been designed to be simplified, ultra-efficient and versatile with Lumen Select Technology, 1 luminaire with multiple wattages/lumen outputs in the same traditional body and diffuser making it easier to replace keeping the same appearance through your installation.

KEY INFORMATION

Lumen Output	3,640-5,200lm
Input Power	28/32/36/40W (Watt-select)
Hole Cutout Size	N/A
Install	Surface mount
Dimming Options	NON-DIMMABLE/DALI/0-10V Dimming
Fitting Colour	Grey base
Warranty	5 yr
IP Rating	IP65
Ik Rating	IK10
IC Rating	N/A

PHOTOMETRIC

Efficacy	130 lm/W
LED	SMD
CCT	3000/4000/5000K(CCT-Select)
CRI	>80
Beam Angle	120°

ELECTRICAL

Driver	Integral
Supply Input	200-240V,50/60Hz
Power Factor	>0.95
Useful life @Ta 25°(L70)	50,000hrs
Emergency time	180mins(Emergency Option)
Sensor	Setting via Remote(Sensor Option)

CONSTRUCTION

Housing	Diecast Alumiumn
Optics	Polycarbonate
Adjustable Angle	N/A
Fixings/Hardware	Mounting Screws
Connection Type	N/A
Total Weight	2.1 KG
Dimensions	660x110x95mm
Operating Ambient Temp.	-20 to 45°C
Electrical Classification	Class 1

Atlas

Ats1200

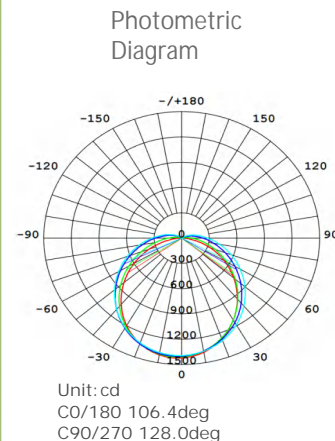
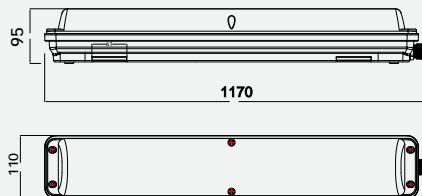

4-Watts Select
3-CCT Select

a Strong IK10 robust weatherproof batten, built for tough conditions.

The control gear has been designed to be simplified, ultra-efficient and versatile with Lumen Select Technology, 1 luminaire with multiple wattages/lumen outputs in the same traditional body and diffuser making it easier to replace keeping the same appearance through your installation.

KEY INFORMATION

Lumen Output	6,240-7,800lm
Input Power	48/52/56/60W (Watt-select)
Hole Cutout Size	N/A
Install	Surface mount
Dimming Options	NON-DIMMABLE/DALI/0-10V Dimming
Fitting Colour	Grey base
Warranty	5 yr
IP Rating	IP65
Ik Rating	IK10
IC Rating	N/A

PHOTOMETRIC

Efficacy	130 lm/W
LED	SMD
CCT	3000/4000/5000K(CCT-Select)
CRI	>80
Beam Angle	120°

ELECTRICAL

Driver	Integral
Supply Input	200-240V,50/60Hz
Power Factor	>0.95
Useful life @Ta 25°(L70)	50,000hrs
Emergency time	180mins(Emergency Option)
Sensor	Setting via Remote(Sensor Option)

CONSTRUCTION

Housing	Diecast Aluminium
Optics	Polycarbonate
Adjustable Angle	N/A
Fixings/Hardware	Mounting Screws
Connection Type	N/A
Total Weight	3.3 KG
Dimensions	1170x110x95mm
Operating Ambient Temp.	-20 to 45°C
Electrical Classification	Class 1

Selos

Sel600

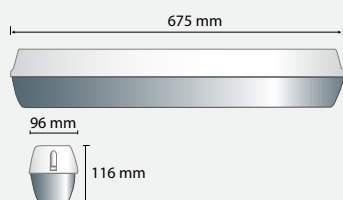

The ability to select your preferred lumen output/wattage within one light fitting.

These are the perfect option when simple functionality is required. Rear and side entry options for easy linking and conduit entry. Combined diffuser and gear tray lead to exceptionally fast fit off. Vandal resistant latches can be secured to stop any tampering. 3 Colour selection with a fixed power driver.



Photometric Diagram

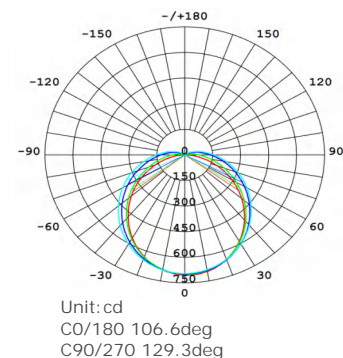

KEY INFORMATION

Lumen Output	1,100-2,200 lm
Input Power	10W/20W (Watt-select)
Hole Cutout Size	N/A
Install	N/A
Dimming Options	NON-DIMMABLE
Fitting Colour	Grey base
Warranty	3 yr
IP Rating	IP65
Ik Rating	IK08
IC Rating	N/A

PHOTOMETRIC

Efficacy	110 lm/W
LED	SMD
CCT	3000/4000/5000K(CCT-Select)
CRI	>80
Beam Angle	120°

ELECTRICAL

Driver	Integral
Supply Input	200-240V,50/60Hz
Power Factor	>0.95
Useful life @Ta 25°(L70)	50,000hrs
Emergency time	180mins(Emergency Option)
Sensor	Setting via Remote(Sensor Option)

CONSTRUCTION

Housing	Polycarbonate
Optics	Polycarbonate
Adjustable Angle	N/A
Fixings/Hardware	Mounting Screws
Connection Type	N/A
Total Weight	2.00 KG
Dimensions	675x96x116mm
Operating Ambient Temp.	-20 to 45°C
Electrical Classification	Class 1

Spoti

Spt90

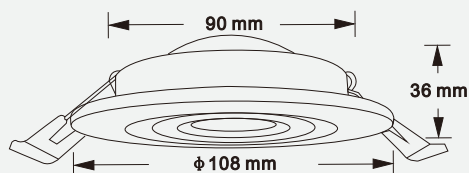

SPOTI multi-function fixed or gimble 60 degree beam reflector style downlight.

A low maintenance solution that is Ideal for residential apartments, foyers, retail, restaurants and clubs where an energy efficient and reliable lamp performance is essential.

Optional
Triac/DALI/0-10V Dimming



CCT-Select

Photometric Diagram

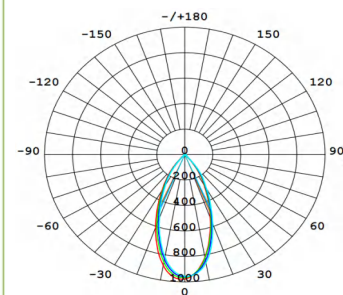

Unit: cd
 CO/180 45.6deg
 C90/270 45.6deg

KEY INFORMATION

Lumen Output	720 lm
Input Power	9W
Hole Cutout Size	90mm
Install	Recessed
Dimming Options	Triac/DALI/0-10V DIMMABLE
Fitting Colour	WHITE
Warranty	5 yr
IP Rating	IP44
Ik Rating	N/A
IC Rating	IC-4

PHOTOMETRIC

Efficacy	80 lm/W
LED	COB
CCT	3000/4000/5000K(CCT-select)
CRI	>90
Beam Angle	45°/60°

ELECTRICAL

Driver	External
Supply Input	200-240V,50/60Hz
Power Factor	>0.95
Useful life @Ta 25°(L70)	50,000hrs
Emergency time	N/A
Sensor	N/A

CONSTRUCTION

Housing	Diecasting Alumiunm
Optics	Optics Lens
Adjustable Angle	60°
Fixings/Hardware	N/A
Connection Type	N/A
Total Weight	370 g
Dimensions	φ108xH36mm
Operating Ambient Temp.	-20 to 45°C
Electrical Classification	Class II

Stellar

StI90

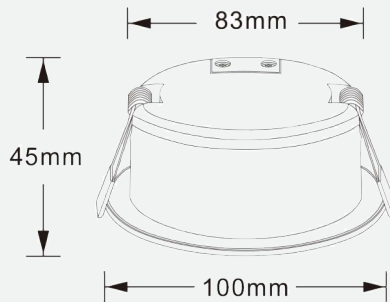

STELLAR multi-function fixed or gimble 60 degree beam reflector style downlight.

A low maintenance solution that is Ideal for residential apartments, foyers, retail, restaurants and clubs where an energy efficient and reliable lamp performance is essential.

Optional
Triac/DALI/0-10V Dimming



CCT-Select

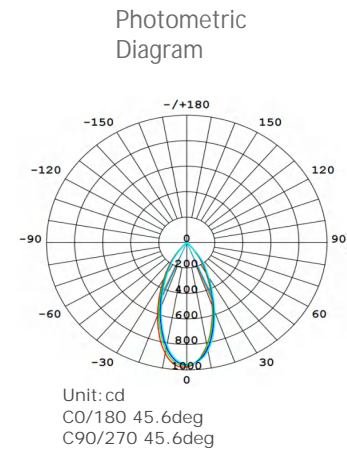

KEY INFORMATION

Lumen Output	720 lm
Input Power	9W
Hole Cutout Size	90mm
Install	Recessed
Dimming Options	Triac/DALI/0-10V DIMMABLE
Fitting Colour	WHITE
Warranty	5 yr
IP Rating	IP44
Ik Rating	N/A
IC Rating	IC-4

PHOTOMETRIC

Efficacy	80 lm/W
LED	COB
CCT	3000/4000/5000K(CCT-select)
CRI	>90
Beam Angle	45°/60°

ELECTRICAL

Driver	External
Supply Input	200-240V,50/60Hz
Power Factor	>0.95
Useful life @Ta 25°(L70)	50,000hrs
Emergency time	N/A
Sensor	N/A

CONSTRUCTION

Housing	Diecasting Aluminum
Optics	Optics Lens
Adjustable Angle	60°
Fixings/Hardware	N/A
Connection Type	N/A
Total Weight	360 g
Dimensions	φ108xH36mm
Operating Ambient Temp.	-20 to 45°C
Electrical Classification	Class II

Mars

Mas70

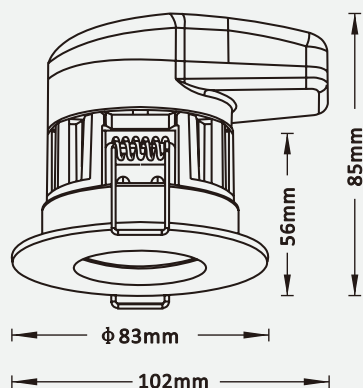

MARS is a multi-function fixed fire rated led downlight.

A low maintenance solution that is Ideal for residential apartments, foyers, retail, restaurants and clubs where an energy efficient and reliable lamp performance is essential.

Optional
 Triac/DALI/0-10V Dimming



CCT-Select

Photometric Diagram

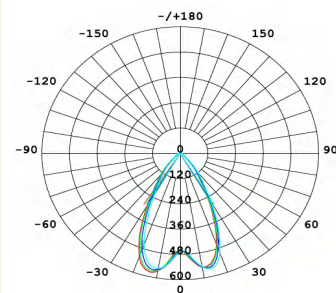

Unit: cd
 CO/180 62.6deg
 C90/270 61.6deg

KEY INFORMATION

Lumen Output	560 lm
Input Power	7W
Hole Cutout Size	70mm
Install	Recessed
Dimming Options	Triac/DALI/0-10V DIMMABLE
Fitting Colour	WHITE
Warranty	5 yr
IP Rating	IP44
Ik Rating	N/A
IC Rating	IC-4

PHOTOMETRIC

Efficacy	80 lm/W
LED	COB
CCT	2700/3000/4000K(CCT-select)
CRI	>90
Beam Angle	60°

ELECTRICAL

Driver	Internal
Supply Input	200-240V,50/60Hz
Power Factor	>0.95
Useful life @Ta 25°(L70)	50,000hrs
Emergency time	N/A
Sensor	N/A

CONSTRUCTION

Housing	Diecasting Aluminum
Optics	Optics Lens
Adjustable Angle	N/A
Fixings/Hardware	N/A
Connection Type	N/A
Total Weight	220 g
Dimensions	φ83xH85mm
Operating Ambient Temp.	-20 to 45°C
Electrical Classification	Class II

Lumia

Lum90

Tritone colour selection allows easy adjustment of colour temperature.

Tritone selectable
 Built-in dimmable driver (1-100%)
 IC-4 rating (ta 25°C)
 Recessed diffuser
 IP44 from below



CCT-Select

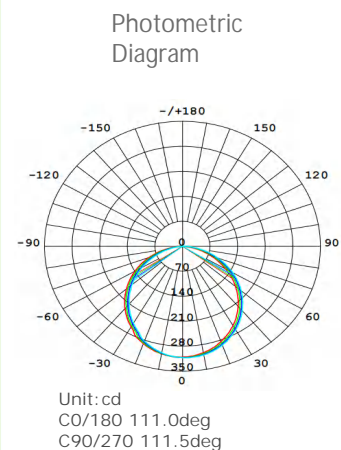

KEY INFORMATION

Lumen Output	855 lm
Input Power	9W
Hole Cutout Size	90mm
Install	Recessed
Dimming Options	Triac DIMMABLE
Fitting Colour	WHITE
Warranty	3 yr
IP Rating	IP44
Ik Rating	N/A
IC Rating	IC-4

PHOTOMETRIC

Efficacy	95 lm/W
LED	SMD
CCT	3000/4000/5000K(CCT-select)
CRI	>80
Beam Angle	110°

ELECTRICAL

Driver	Internal
Supply Input	200-240V,50/60Hz
Power Factor	>0.9
Useful life @Ta 25°(L70)	50,000hrs
Emergency time	N/A
Sensor	N/A

CONSTRUCTION

Housing	Polycarbonate
Optics	Polycarbonate
Adjustable Angle	N/A
Fixings/Hardware	N/A
Connection Type	N/A
Total Weight	250 g
Dimensions	φ115xH58mm
Operating Ambient Temp.	-20 to 45°C
Electrical Classification	Class II

Lumia

Lum70

Tritone colour selection allows easy adjustment of colour temperature.

Tritone selectable
 Built-in dimmable driver (1-100%)
 IC-4 rating (ta 25°C)
 Recessed diffuser
 IP44 from below



CCT-Select

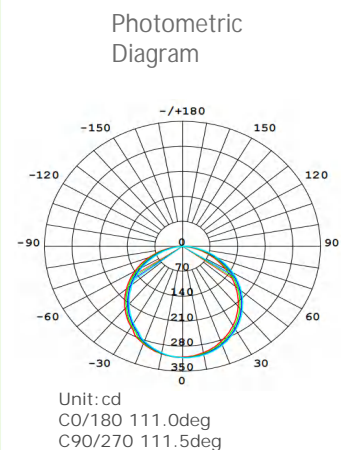

KEY INFORMATION

Lumen Output	630 lm
Input Power	7W
Hole Cutout Size	70mm
Install	Recessed
Dimming Options	Triac DIMMABLE
Fitting Colour	WHITE
Warranty	3 yr
IP Rating	IP44
Ik Rating	N/A
IC Rating	IC-4

PHOTOMETRIC

Efficacy	90 lm/W
LED	SMD
CCT	3000/4000/5000K(CCT-select)
CRI	>80
Beam Angle	110°

ELECTRICAL

Driver	Internal
Supply Input	200-240V,50/60Hz
Power Factor	>0.9
Useful life @Ta 25°(L70)	50,000hrs
Emergency time	N/A
Sensor	N/A

CONSTRUCTION

Housing	Polycarbonate
Optics	Polycarbonate
Adjustable Angle	N/A
Fixings/Hardware	N/A
Connection Type	N/A
Total Weight	220 g
Dimensions	φ97xH55mm
Operating Ambient Temp.	-20 to 45°C
Electrical Classification	Class II

Vivid

Vid250

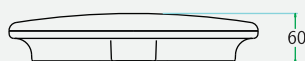
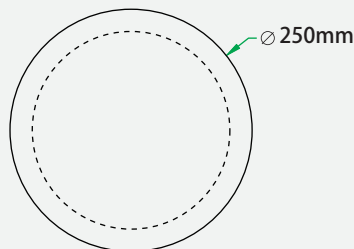

A slimline quick installation ceiling light with improved efficacy and output.

Vivid comes with quick fit mounting bracket, integral control gear and offers discrete appearance for residential, commercial and retail applications. Colour temperature can be set at 3000K, 4000K or 5000K with switch located on the back of the fitting.

Optional:
DALI/0-10V Dimming



CCT-Select

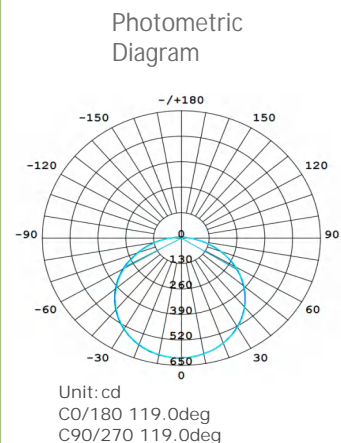

KEY INFORMATION

Lumen Output	1,440 lm
Input Power	12W
Hole Cutout Size	N/A
Install	Surface Mount
Dimming Options	NON-DIMMABLE/DALI/0-10V DIMMABLE
Fitting Colour	WHITE
Warranty	5 yr
IP Rating	IP44
Ik Rating	N/A
IC Rating	N/A

PHOTOMETRIC

Efficacy	120 lm/W
LED	SMD
CCT	3000/4000/5000K(CCT-select)
CRI	>80
Beam Angle	120°

ELECTRICAL

Driver	Integral
Supply Input	200-240V,50/60Hz
Power Factor	>0.95
Useful life @Ta 25°(L70)	50,000hrs
Emergency time	N/A
Sensor	Microwave(Sensor optional)

CONSTRUCTION

Housing	Polycarbonate
Optics	Polycarbonate
Adjustable Angle	N/A
Fixings/Hardware	Mounting plate
Connection Type	N/A
Total Weight	450 g
Dimensions	φ250xH60mm
Operating Ambient Temp.	-20 to 45°C
Electrical Classification	Class 1

Vivid

Vid300

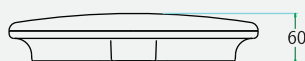
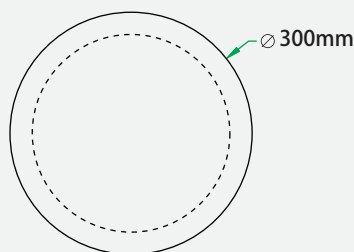

A slimline quick installation ceiling light with improved efficacy and output.

Vivid comes with quick fit mounting bracket, integral control gear and offers discrete appearance for residential, commercial and retail applications. Colour temperature can be set at 3000K, 4000K or 5000K with switch located on the back of the fitting.

Optional:
DALI/0-10V Dimming



CCT-Select

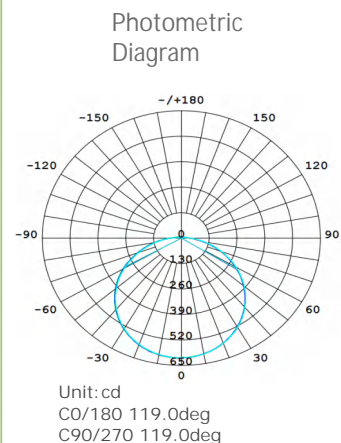

KEY INFORMATION

Lumen Output	2,160 lm
Input Power	18W
Hole Cutout Size	N/A
Install	Surface Mount
Dimming Options	NON-DIMMABLE/DALI/0-10V DIMMABLE
Fitting Colour	WHITE
Warranty	5 yr
IP Rating	IP44
Ik Rating	N/A
IC Rating	N/A

PHOTOMETRIC

Efficacy	120 lm/W
LED	SMD
CCT	3000/4000/5000K(CCT-select)
CRI	>80
Beam Angle	120°

ELECTRICAL

Driver	Integral
Supply Input	200-240V,50/60Hz
Power Factor	>0.95
Useful life @Ta 25°(L70)	50,000hrs
Emergency time	N/A
Sensor	Microwave(Sensor optional)

CONSTRUCTION

Housing	Polycarbonate
Optics	Polycarbonate
Adjustable Angle	N/A
Fixings/Hardware	Mounting plate
Connection Type	N/A
Total Weight	850 g
Dimensions	φ300xH60mm
Operating Ambient Temp.	-20 to 45°C
Electrical Classification	Class 1

Vivid

Vid380

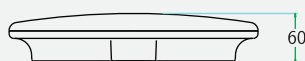
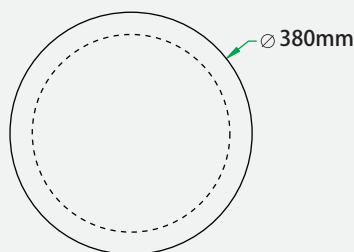

A slimline quick installation ceiling light with improved efficacy and output.

Vivid comes with quick fit mounting bracket, integral control gear and offers discrete appearance for residential, commercial and retail applications. Colour temperature can be set at 3000K, 4000K or 5000K with switch located on the back of the fitting.

Optional:
DALI/0-10V Dimming



CCT-Select

Photometric Diagram

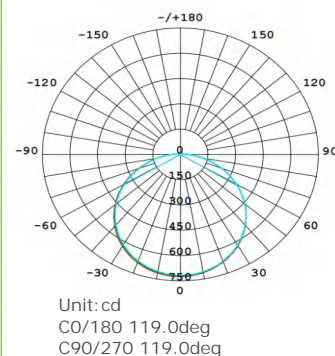

KEY INFORMATION

Lumen Output	2,880 lm
Input Power	24W
Hole Cutout Size	N/A
Install	Surface Mount
Dimming Options	NON-DIMMABLE/DALI/0-10V DIMMABLE
Fitting Colour	WHITE
Warranty	5 yr
IP Rating	IP44
Ik Rating	N/A
IC Rating	N/A

PHOTOMETRIC

Efficacy	120 lm/W
LED	SMD
CCT	3000/4000/5000K(CCT-select)
CRI	>80
Beam Angle	120°

ELECTRICAL

Driver	Integral
Supply Input	200-240V,50/60Hz
Power Factor	>0.95
Useful life @Ta 25°(L70)	50,000hrs
Emergency time	N/A
Sensor	Microwave(Sensor optional)

CONSTRUCTION

Housing	Polycarbonate
Optics	Polycarbonate
Adjustable Angle	N/A
Fixings/Hardware	Mounting plate
Connection Type	N/A
Total Weight	1.4 KG
Dimensions	φ380xH60mm
Operating Ambient Temp.	-20 to 45°C
Electrical Classification	Class 1

Uranx

Urx3060

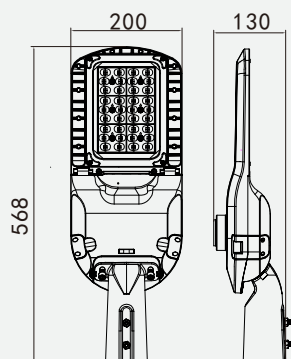

A slimline performance street lantern with improved efficacy and output.

Uranx offers a choice of optics with asymmetrical distribution including an area optic.

Optional Accessories
 Shorting Cap/PE Cell
 DALI/0-10V Dimming



Watt-Select
 CCT-Select

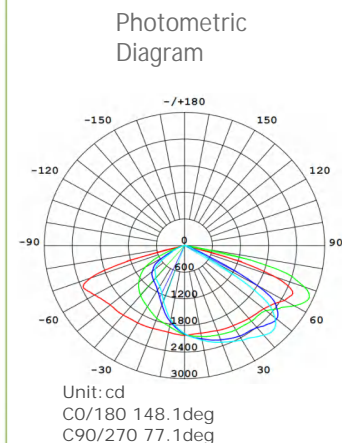

KEY INFORMATION

Lumen Output	4,500 lm/7800lm
Input Power	30W/60W(Watt-select)
Hole Cutout Size	N/A
Install	N/A
Dimming Options	NON-DIMMABLE/DALI/0-10V DIMMABLE
Fitting Colour	BLACK
Warranty	5 yr
IP Rating	IP66
Ik Rating	IK08
IC Rating	N/A

PHOTOMETRIC

Efficacy	130-150 lm/W
LED	SMD
CCT	3000/4000/5000K(CCT-select)
CRI	>80
Beam Angle	80°x150°

ELECTRICAL

Driver	Integral
Supply Input	90-305V,50/60Hz
Power Factor	>0.95
Useful life @Ta 25°(L70)	50,000hrs
Emergency time	N/A
Sensor	PE CELL Available

CONSTRUCTION

Housing	Aluminium
Optics	Tempered Glass
Adjustable Angle	90°
Fixings/Hardware	Mounting Screws
Connection Type	N/A
Total Weight	4.8 KG
Dimensions	568x200x109mm(No shorting cap)
Operating Ambient Temp.	-20 to 45°C
Electrical Classification	Class 1

Uranx

Urx100

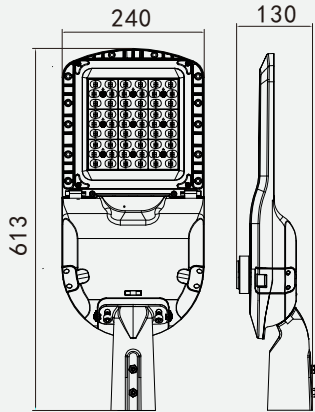

A slimline performance street lantern with improved efficacy and output.

Uranx offers a choice of optics with asymmetrical distribution including an area optic.

Optional Accessories
 Shorting Cap/PE Cell
 DALI/0-10V Dimming



CCT-Select

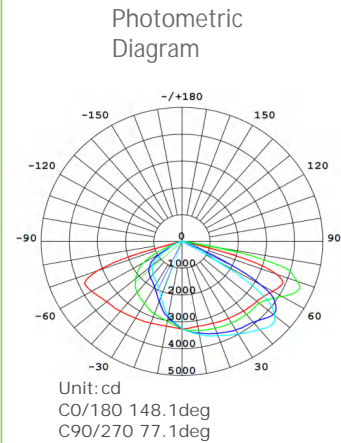

KEY INFORMATION

Lumen Output	13,000 lm
Input Power	100W
Hole Cutout Size	N/A
Install	N/A
Dimming Options	NON-DIMMABLE/DALI/0-10V DIMMABLE
Fitting Colour	BLACK
Warranty	5 yr
IP Rating	IP66
Ik Rating	IK08
IC Rating	N/A

PHOTOMETRIC

Efficacy	130 lm/W
LED	SMD
CCT	3000/4000/5000K(CCT-select)
CRI	>80
Beam Angle	80°x150°

ELECTRICAL

Driver	Integral
Supply Input	90-305V,50/60Hz
Power Factor	>0.95
Useful life @Ta 25°(L70)	50,000hrs
Emergency time	N/A
Sensor	PE CELL Available

CONSTRUCTION

Housing	Aluminium
Optics	Tempered Glass
Adjustable Angle	90°
Fixings/Hardware	Mounting Screws
Connection Type	N/A
Total Weight	5.2 KG
Dimensions	613x240x109mm(No shorting cap)
Operating Ambient Temp.	-20 to 45°C
Electrical Classification	Class 1

Uranx

Urx150

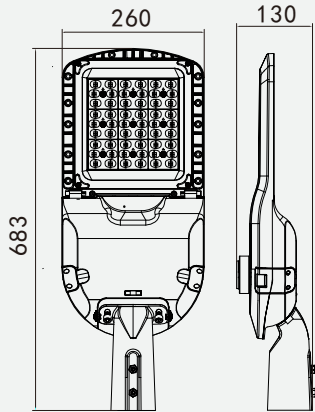

A slimline performance street lantern with improved efficacy and output.

Uranx offers a choice of optics with asymmetrical distribution including an area optic.

Optional Accessories
 Shorting Cap/PE Cell
 DALI/0-10V Dimming



CCT-Select

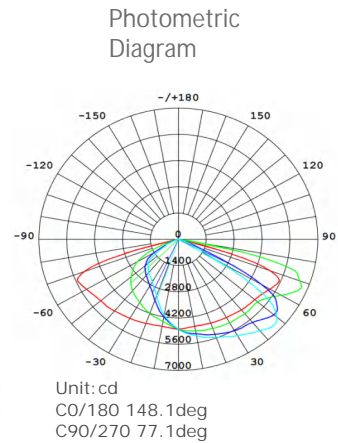

KEY INFORMATION

Lumen Output	19,500 lm
Input Power	150W
Hole Cutout Size	N/A
Install	N/A
Dimming Options	NON-DIMMABLE/DALI/0-10V DIMMABLE
Fitting Colour	BLACK
Warranty	5 yr
IP Rating	IP66
Ik Rating	IK08
IC Rating	N/A

PHOTOMETRIC

Efficacy	130 lm/W
LED	SMD
CCT	3000/4000/5000K(CCT-select)
CRI	>80
Beam Angle	80°x150°

ELECTRICAL

Driver	Integral
Supply Input	90-305V,50/60Hz
Power Factor	>0.95
Useful life @Ta 25°(L70)	50,000hrs
Emergency time	N/A
Sensor	PE CELL Available

CONSTRUCTION

Housing	Aluminium
Optics	Tempered Glass
Adjustable Angle	90°
Fixings/Hardware	Mounting Screws
Connection Type	N/A
Total Weight	6.1 KG
Dimensions	683x260x109mm(No shorting cap)
Operating Ambient Temp.	-20 to 45°C
Electrical Classification	Class 1

Uranx

Urx200

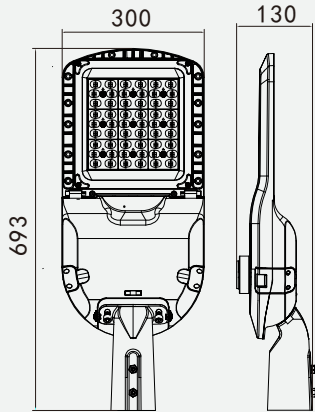

A slimline performance street lantern with improved efficacy and output.

Uranx offers a choice of optics with asymmetrical distribution including an area optic.

Optional Accessories
 Shorting Cap/PE Cell
 DALI/0-10V Dimming



CCT-Select

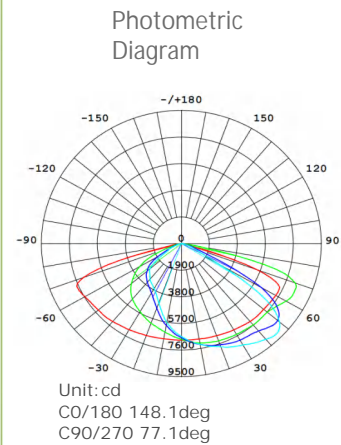

KEY INFORMATION

Lumen Output	26,000 lm
Input Power	200W
Hole Cutout Size	N/A
Install	N/A
Dimming Options	NON-DIMMABLE/DALI/0-10V DIMMABLE
Fitting Colour	BLACK
Warranty	5 yr
IP Rating	IP66
Ik Rating	IK08
IC Rating	N/A

PHOTOMETRIC

Efficacy	130 lm/W
LED	SMD
CCT	3000/4000/5000K(CCT-select)
CRI	>80
Beam Angle	80°x150°

ELECTRICAL

Driver	Integral
Supply Input	90-305V,50/60Hz
Power Factor	>0.95
Useful life @Ta 25°(L70)	50,000hrs
Emergency time	N/A
Sensor	PE CELL Available

CONSTRUCTION

Housing	Aluminium
Optics	Tempered Glass
Adjustable Angle	90°
Fixings/Hardware	Mounting Screws
Connection Type	N/A
Total Weight	6.7 KG
Dimensions	693x300x109mm(No shorting cap)
Operating Ambient Temp.	-20 to 45°C
Electrical Classification	Class 1

Uranx

Urx300

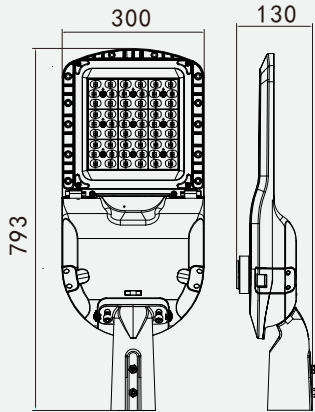

A slimline performance street lantern with improved efficacy and output.

Uranx offers a choice of optics with asymmetrical distribution including an area optic.

Optional Accessories
 Shorting Cap/PE Cell
 DALI/0-10V Dimming



CCT-Select

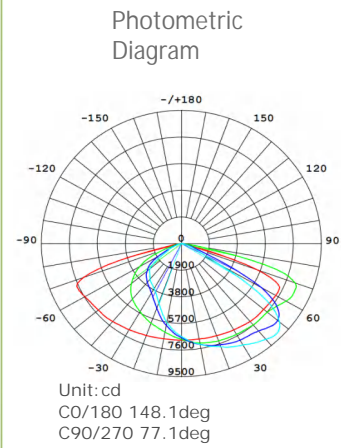

KEY INFORMATION

Lumen Output	39,000 lm
Input Power	300W
Hole Cutout Size	N/A
Install	N/A
Dimming Options	NON-DIMMABLE/DALI/0-10V DIMMABLE
Fitting Colour	BLACK
Warranty	5 yr
IP Rating	IP66
Ik Rating	IK08
IC Rating	N/A

PHOTOMETRIC

Efficacy	130 lm/W
LED	SMD
CCT	3000/4000/5000K(CCT-select)
CRI	>80
Beam Angle	80°x150°

ELECTRICAL

Driver	Integral
Supply Input	90-305V,50/60Hz
Power Factor	>0.95
Useful life @Ta 25°(L70)	50,000hrs
Emergency time	N/A
Sensor	PE CELL Available

CONSTRUCTION

Housing	Aluminium
Optics	Tempered Glass
Adjustable Angle	90°
Fixings/Hardware	Mounting Screws
Connection Type	N/A
Total Weight	7.9 KG
Dimensions	793x300x109mm(No shorting cap)
Operating Ambient Temp.	-20 to 45°C
Electrical Classification	Class 1

Skyla

Sky100-L

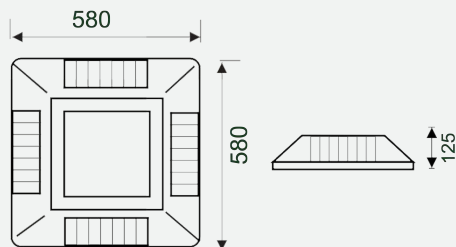

An industrial-grade commercial fixture for ceiling and canopy lighting.

The uniquely designed housing ensures optimum thermal management for the integrated LED module. SKYLA series is easy to install onto a variety of ceiling surfaces and can be used for any industrial or commercial project. Typical applications include carparks, petrol stations, warehouses etc.

Optional Accessories

Installation plate



Photometric Diagram

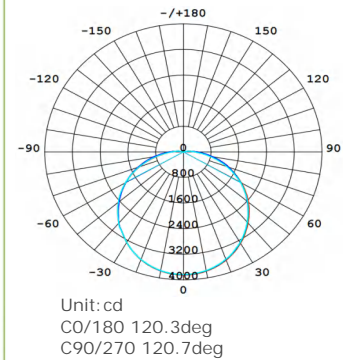

KEY INFORMATION

Lumen Output	13,000 lm
Input Power	100W
Hole Cutout Size	N/A
Install	N/A
Dimming Options	NON-DIMMABLE
Fitting Colour	White
Warranty	5 yr
IP Rating	IP66
Ik Rating	IK10
IC Rating	N/A

PHOTOMETRIC

Efficacy	130 lm/W
LED	SMD
CCT	5000K
CRI	>80
Beam Angle	120°

ELECTRICAL

Driver	Meanwell
Supply Input	90-305V,50/60Hz
Power Factor	>0.95
Useful life @Ta 25°(L70)	50,000hrs
Emergency time	N/A
Sensor	N/A

CONSTRUCTION

Housing	Aluminium
Optics	Polycarbonate
Adjustable Angle	N/A
Fixings/Hardware	Mounting Screws
Connection Type	N/A
Total Weight	11.3KG
Dimensions	580x580x125mm
Operating Ambient Temp.	-20 to 45°C
Electrical Classification	Class 1

Skyla

Sky100-S

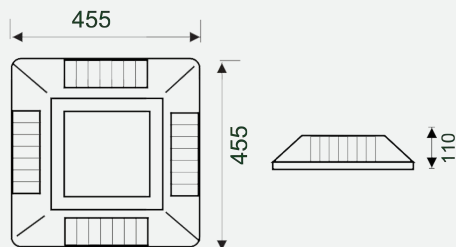

An industrial-grade commercial fixture for ceiling and canopy lighting.

The uniquely designed housing ensures optimum thermal management for the integrated LED module. SKYLA series is easy to install onto a variety of ceiling surfaces and can be used for any industrial or commercial project. Typical applications include carparks, petrol stations, warehouses etc.

Optional Accessories

Installation plate



Photometric Diagram

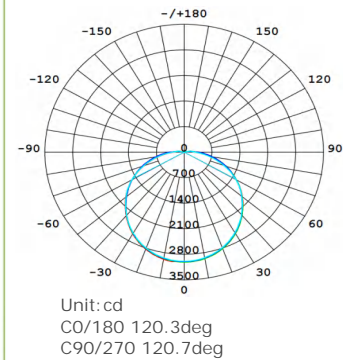

KEY INFORMATION

Lumen Output	10,000 lm
Input Power	100W
Hole Cutout Size	N/A
Install	N/A
Dimming Options	NON-DIMMABLE
Fitting Colour	White
Warranty	5 yr
IP Rating	IP66
Ik Rating	IK10
IC Rating	N/A

PHOTOMETRIC

Efficacy	100 lm/W
LED	SMD
CCT	5000K
CRI	>80
Beam Angle	120°

ELECTRICAL

Driver	Meanwell
Supply Input	90-305V,50/60Hz
Power Factor	>0.95
Useful life @Ta 25°(L70)	50,000hrs
Emergency time	N/A
Sensor	N/A

CONSTRUCTION

Housing	Aluminium
Optics	Polycarbonate
Adjustable Angle	N/A
Fixings/Hardware	Mounting Screws
Connection Type	N/A
Total Weight	6.7KG
Dimensions	455x455x110mm
Operating Ambient Temp.	-20 to 45°C
Electrical Classification	Class 1

Skyla

Sky150-L

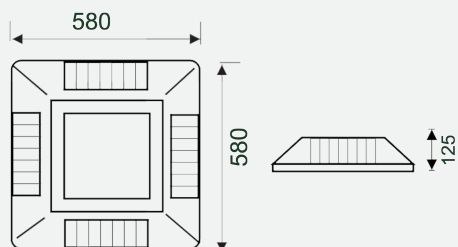

An industrial-grade commercial fixture for ceiling and canopy lighting.

The uniquely designed housing ensures optimum thermal management for the integrated LED module. SKYLA series is easy to install onto a variety of ceiling surfaces and can be used for any industrial or commercial project. Typical applications include carparks, petrol stations, warehouses etc.

Optional Accessories

Installation plate



Photometric Diagram

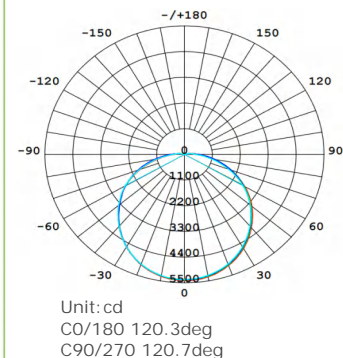

KEY INFORMATION

Lumen Output	18,000 lm
Input Power	150W
Hole Cutout Size	N/A
Install	N/A
Dimming Options	NON-DIMMABLE
Fitting Colour	White
Warranty	5 yr
IP Rating	IP66
Ik Rating	IK10
IC Rating	N/A

PHOTOMETRIC

Efficacy	120 lm/W
LED	SMD
CCT	5000K
CRI	>80
Beam Angle	120°

ELECTRICAL

Driver	Meanwell
Supply Input	90-305V,50/60Hz
Power Factor	>0.95
Useful life @Ta 25°(L70)	50,000hrs
Emergency time	N/A
Sensor	N/A

CONSTRUCTION

Housing	Aluminium
Optics	Polycarbonate
Adjustable Angle	N/A
Fixings/Hardware	Mounting Screws
Connection Type	N/A
Total Weight	11.3KG
Dimensions	580x580x125mm
Operating Ambient Temp.	-20 to 45°C
Electrical Classification	Class 1

Skyla

Sky200-L

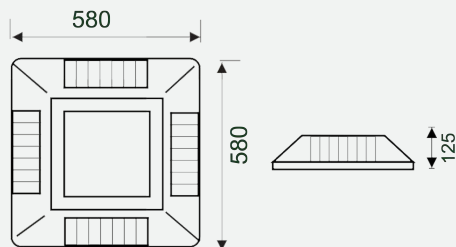

An industrial-grade commercial fixture for ceiling and canopy lighting.

The uniquely designed housing ensures optimum thermal management for the integrated LED module. SKYLA series is easy to install onto a variety of ceiling surfaces and can be used for any industrial or commercial project. Typical applications include carparks, petrol stations, warehouses etc.

Optional Accessories

Installation plate



Photometric Diagram

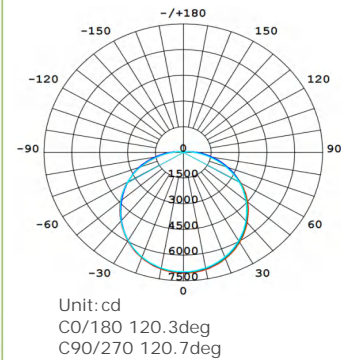

KEY INFORMATION

Lumen Output	24,000 lm
Input Power	200W
Hole Cutout Size	N/A
Install	N/A
Dimming Options	NON-DIMMABLE
Fitting Colour	White
Warranty	5 yr
IP Rating	IP66
Ik Rating	IK10
IC Rating	N/A

PHOTOMETRIC

Efficacy	120 lm/W
LED	SMD
CCT	5000K
CRI	>80
Beam Angle	120°

ELECTRICAL

Driver	Meanwell
Supply Input	90-305V,50/60Hz
Power Factor	>0.95
Useful life @Ta 25°(L70)	50,000hrs
Emergency time	N/A
Sensor	N/A

CONSTRUCTION

Housing	Aluminium
Optics	Polycarbonate
Adjustable Angle	N/A
Fixings/Hardware	Mounting Screws
Connection Type	N/A
Total Weight	11.3KG
Dimensions	580x580x125mm
Operating Ambient Temp.	-20 to 45°C
Electrical Classification	Class 1

Explores Possibilities

LUMIEVO