

# Lumievo



V2025

# PRODUCT CONTENTS

## LED BULKHEAD LIGHT

**04**

DUSAR 300  
Polycarbonate



**05**

DUSAR 275  
Die-cast AL



**06**

DUSAR 350  
Die-cast AL



**07**

DUSAR  
SOLAR



**08**

DUSAR 10  
small oval



**09**

DUSAR 16  
large oval



**10**

DIONE  
Square



**11**

DUSK  
Wallpack



**13**

DROME  
Wall Light



## LED FLOOD LIGHT

**14**

NEXUS 100  
3CCT&3Watts



**15**

NEXUS 200  
3CCT&3Watts



**16**

LUMOS  
100w-400w



**20**

LUXOR  
50w-400w



**26**

GAIA  
500W



## WEATHER PROOF LED BATTEN

**27**

ASTRO  
3CCT&2Watts



**29**

ASTRO  
Multi-colors



**31**

ATLAS  
IK10 AL



**33**

SELOS  
IK10 PC



## LED DOWNLIGHT

**34**

SPOTI



**35**

STELLAR



**36**

MARS



**37**

LUMIA



**38**

LUMIA II



**39**

ARCHI



## LED CEILING LIGHT

**41**

VIVID



## LED STREET LIGHT

**44**

URANX



**49**

URANX  
Solar



## LED CANOPY LIGHT

**50**

SKYLA



## Installation Hardware

**54**

Pole Clamp



**55**

Pole Adaptor



**56**

Pole Mounting  
Clamp Bracke



**57**

Tri-Bracket



**58**

Double-Bracket



**59**

Adjustable  
Pole Mount



**60**

Extention  
Arm



**61**

Flat Mount  
Streetlight Bracel



# Dusar

DSR300

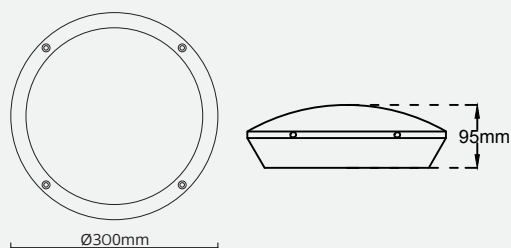

Weather and impact resistant, Selectable colour temperature, LED Bulkhead light Double insulated

A round robust bulkhead light constructed with polycarbonated body and opal diffuser providing decorative solution for both residential and commercial applications.

Microwave and daylight sensor option.

Accessories  
Eyelid TRIM



Photometric Diagram

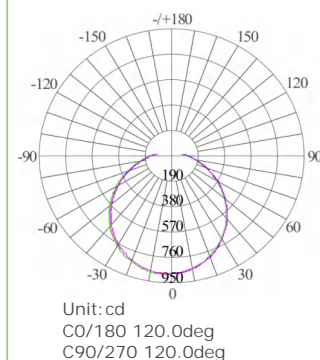

## KEY INFORMATION

Lumen Output	<b>1050lm/1680lm</b>
Input Power	<b>12W/16W(Watt-select)</b>
Hole Cutout Size	<b>N/A</b>
Install	<b>SURFACE MOUNT</b>
Dimming Options	<b>NON-DIMMABLE</b>
Fitting Colour	<b>BLACK/White</b>
Warranty	<b>3 yr</b>
IP Rating	<b>IP65</b>
Ik Rating	<b>IK10</b>
IC Rating	<b>N/A</b>

## PHOTOMETRIC

Efficacy	<b>105 lm/W</b>
LED	<b>SMD</b>
CCT	<b>3000/4000/5000K (CCT-Selectable)</b>
CRI	<b>&gt;80</b>
Beam Angle	<b>120°</b>

## ELECTRICAL

Driver	<b>Integral</b>
Supply Input	<b>220-240V,50/60Hz</b>
Power Factor	<b>&gt;0.9</b>
Useful life @Ta 25°(L70)	<b>50,000hrs</b>

## CONSTRUCTION

Housing	<b>Polycarbonate</b>
Optics	<b>Polycarbonate Diffuser</b>
Adjustable Angle	<b>N/A</b>
Fixings/Hardware	<b>Mounting Screws</b>
Connection Type	<b>Terminal Block</b>
Total Weight	<b>1.6KG</b>
Dimensions	<b>300x95mm</b>
Operating Ambient Temp.	<b>-20 to 45°C</b>
Electrical Classification	<b>Class 1</b>

# Dusar

DSR275  
 DSR275-EM  
 DSR275-MS  
 DSR275-EM-MS

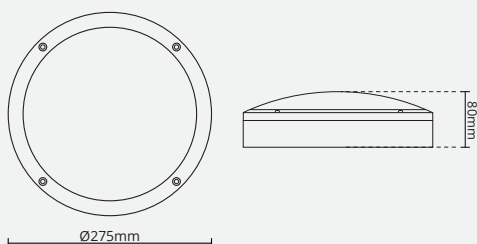

Weather and  
 impact resistant,  
 Selectable colour  
 temperature, LED  
 Bulkhead light

A round robust bulkhead light constructed with aluminum body and opal diffuser providing decorative solution for both residential and commercial applications.

Sensor and Emergency options.

Accessories  
 Optional TRIM  
 Eyelid/Cross/Grille



Photometric  
 Diagram

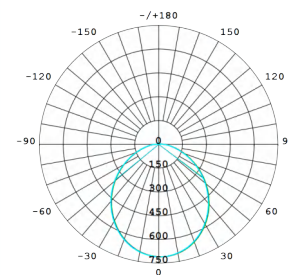

Unit: cd  
 C0/180 120.0deg  
 C90/270 120.0deg

## KEY INFORMATION

Lumen Output	1050 / 2050 lm
Input Power	10W/20W(Watt-selectable)
Hole Cutout Size	N/A
Install	<b>SURFACE MOUNT</b>
Dimming Options	<b>NON-DIMMABLE</b>
Fitting Colour	<b>BLACK/White</b>
Warranty	5 yr
IP Rating	<b>IP66</b>
Ik Rating	<b>IK10</b>
IC Rating	N/A

## PHOTOMETRIC

Efficacy	100-110 lm/W
LED	<b>SMD</b>
CCT	<b>3000/4000/5000K (CCT-Selectable)</b>
CRI	<b>&gt;80</b>
Beam Angle	<b>120°</b>

## ELECTRICAL

Driver	<b>Integral</b>
Supply Input	<b>220-240V,50/60Hz</b>
Power Factor	<b>&gt;0.9</b>
Useful life @Ta 25°(L70)	<b>50,000hrs</b>

## CONSTRUCTION

Housing	<b>Die-cast Aluminum</b>
Optics	<b>Polycarbonate Diffuser</b>
Adjustable Angle	<b>N/A</b>
Fixings/Hardware	<b>Mounting Screws</b>
Connection Type	<b>Terminal Block</b>
Total Weight	<b>1.3KG</b>
Dimensions	<b>275x80mm</b>
Operating Ambient Temp.	<b>-20 to 45°C</b>
Electrical Classification	<b>Class 1</b>

# Dusar

DSR350  
 DSR350-EM  
 DSR350-MS  
 DSR350-EM-MS

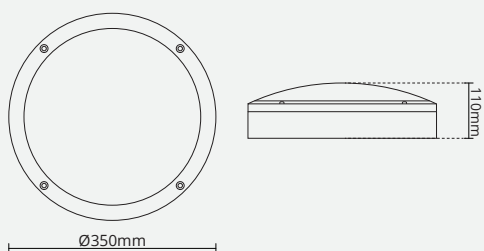

Weather and impact resistant, Selectable colour temperature, LED Bulkhead light

A large round robust bulkhead light constructed with aluminium body and opal diffuser providing decorative solution for both residential and commercial applications.

Sensor and Emergency options.

Accessories  
 Optional TRIM  
 Eyelid



Photometric Diagram

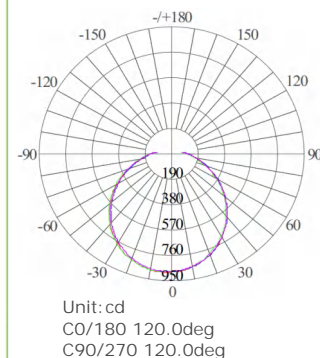

## KEY INFORMATION

Lumen Output	3050 lm
Input Power	30W
Hole Cutout Size	N/A
Install	SURFACE MOUNT
Dimming Options	NON-DIMMABLE
Fitting Colour	BLACK/White
Warranty	5 yr
IP Rating	IP66
Ik Rating	IK10
IC Rating	N/A

## PHOTOMETRIC

Efficacy	100-110 lm/W
LED	SMD
CCT	3000/4000/5000K (CCT-Selectable)
CRI	>80
Beam Angle	120°

## ELECTRICAL

Driver	Integral
Supply Input	220-240V,50/60Hz
Power Factor	>0.9
Useful life @Ta 25°(L70)	50,000hrs

## CONSTRUCTION

Housing	Aluminium
Optics	Polycarbonate Diffuser
Adjustable Angle	N/A
Fixings/Hardware	Mounting Screws
Connection Type	Terminal Block
Total Weight	2.6KG
Dimensions	350x110mm
Operating Ambient Temp.	-20 to 45°C
Electrical Classification	Class 1

# Dusar Solar

DSR-SL

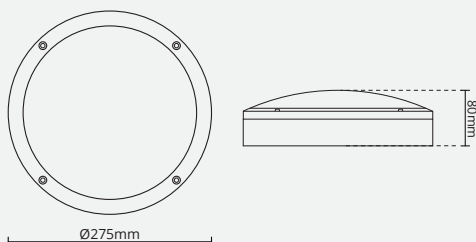

Weather and impact resistant, Durable and long lasting, Solar LED Bulkhead light

A round robust bulkhead light constructed with aluminium body and opal diffuser providing decorative solution for both residential and commercial applications. Automatic night-time operation, Smart power battery detection – LED brightness will be automatically reduced to prolong battery life

Accessories  
Optional TRIM



Photometric Diagram

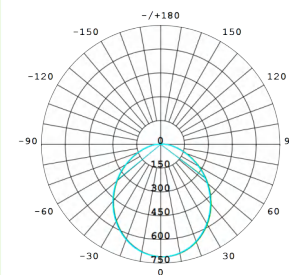

Unit: cd  
 CO/180 120.0deg  
 C90/270 120.0deg

## KEY INFORMATION

Lumen Output	<b>2400 lm</b>
Input Power	<b>20W</b>
Hole Cutout Size	<b>N/A</b>
Install	<b>SURFACE MOUNT</b>
Dimming Options	<b>DIMMABLE</b>
Fitting Colour	<b>BLACK/White</b>
Warranty	<b>3 yr</b>
IP Rating	<b>IP66</b>
Ik Rating	<b>IK10</b>
IC Rating	<b>N/A</b>

## PHOTOMETRIC

Efficacy	<b>120 lm/W</b>
LED	<b>SMD</b>
CCT	<b>6000K</b>
CRI	<b>&gt;80</b>
Beam Angle	<b>120°</b>

## ELECTRICAL

Solar panel	<b>15W 6V</b>
Battery	<b>3.7V 12AH, 44.4wh</b>
Charging time	<b>~8 Hours (from 0-100%)</b>
Operation time	<b>Dusk to dawn</b>
Sensor	<b>Microwave (up-to 10m), 180°</b>
Sensor Function	<b>30% standby, 100% when motion</b>

## CONSTRUCTION

Housing	<b>Aluminium</b>
Optics	<b>Polycarbonate Diffuser</b>
Adjustable Angle	<b>N/A</b>
Fixings/Hardware	<b>Mounting Screws</b>
Solar panel Dimension	<b>350x350x20mm</b>
Total Weight	<b>2.3KG</b>
Light Dimension	<b>275x80mm</b>
Operating Ambient Temp.	<b>-20 to 45°C</b>
Cable to the solar panel	<b>Aluminium</b>

## Warning & Reminding

1. This product includes rechargeable batteries which must be adequately charged under sun light before use.
2. Before install the light, please press on/off button inside the light to get it activated at the first use.
3. The light is equipped with an internal battery pack, which is replaceable.
4. Build-in intelligent IC with over-charge, over-discharge, over-temperature protection.
5. Please do not dispose the battery with household garbage to avoid explosion.
6. Non-professionals please do not disassemble the lamp.

# Dusar

DSO10

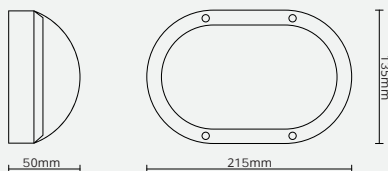

Weather and impact resistant, Selectable colour temperature, LED Bulkhead light

A small oval robust bulkhead light constructed with aluminium body and opal diffuser providing decorative solution for both residential and commercial applications.

Accessories  
Optional TRIM



## Photometric Diagram

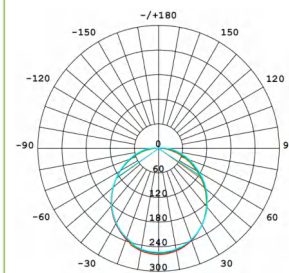

Unit: cd  
 CO/180 120.0deg  
 C90/270 120.0deg

## KEY INFORMATION

Lumen Output	1050lm
Input Power	10W
Hole Cutout Size	N/A
Install	<b>SURFACE MOUNT</b>
Dimming Options	<b>NON-DIMMABLE</b>
Fitting Colour	<b>BLACK/White</b>
Warranty	5 yr
IP Rating	<b>IP66</b>
Ik Rating	<b>IK10</b>
IC Rating	N/A

## PHOTOMETRIC

Efficacy	100-110 lm/W
LED	<b>SMD</b>
CCT	<b>3000/4000/5000K (CCT-Selectable)</b>
CRI	<b>&gt;80</b>
Beam Angle	<b>120°</b>

## ELECTRICAL

Driver	<b>Integral</b>
Supply Input	<b>220-240V,50/60Hz</b>
Power Factor	<b>&gt;0.9</b>
Useful life @Ta 25°(L70)	<b>50,000hrs</b>

## CONSTRUCTION

Housing	<b>Aluminium</b>
Optics	<b>Polycarbonate Diffuser</b>
Adjustable Angle	<b>N/A</b>
Fixings/Hardware	<b>Mounting Screws</b>
Connection Type	<b>Terminal Block</b>
Total Weight	<b>1.0 KG</b>
Dimensions	<b>215x135x50mm</b>
Operating Ambient Temp.	<b>-20 to 45°C</b>
Electrical Classification	<b>Class 1</b>



# Dusar

DSO16  
DSO16-MS

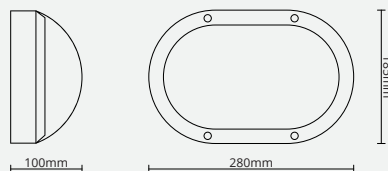

Weather and impact resistant, Selectable colour temperature, LED Bulkhead light

A large oval robust bulkhead light constructed with aluminium body and opal diffuser providing decorative solution for both residential and commercial applications.

Sensor/Photocell Option.

Accessories  
Optional TRIM

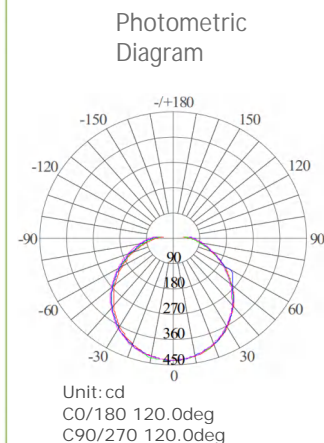

## KEY INFORMATION

Lumen Output	1650 lm
Input Power	16W
Hole Cutout Size	N/A
Install	<b>SURFACE MOUNT</b>
Dimming Options	<b>NON-DIMMABLE</b>
Fitting Colour	<b>BLACK/White</b>
Warranty	5 yr
IP Rating	<b>IP66</b>
Ik Rating	<b>IK10</b>
IC Rating	N/A

## PHOTOMETRIC

Efficacy	100-110 lm/W
LED	<b>SMD</b>
CCT	<b>3000/4000/5000K (CCT-Selectable)</b>
CRI	<b>&gt;80</b>
Beam Angle	<b>120°</b>

## ELECTRICAL

Driver	<b>Integral</b>
Supply Input	<b>220-240V,50/60Hz</b>
Power Factor	<b>&gt;0.9</b>
Useful life @Ta 25°(L70)	<b>50,000hrs</b>

## CONSTRUCTION

Housing	<b>Aluminium</b>
Optics	<b>Polycarbonate Diffuser</b>
Adjustable Angle	<b>N/A</b>
Fixings/Hardware	<b>Mounting Screws</b>
Connection Type	<b>Terminal Block</b>
Total Weight	<b>1.3 KG</b>
Dimensions	<b>280x185x100mm</b>
Operating Ambient Temp.	<b>-20 to 45°C</b>
Electrical Classification	<b>Class 1</b>

# DIONE

DIN270  
 DIN270-EM  
 DIN270-MS  
 DIN270-EM-MS

Weather and  
 impact resistant,  
 Selectable colour  
 temperature, LED  
 Bulkhead light

A square robust bulkhead  
 light constructed with  
 aluminium  
 body and opal diffuser  
 providing decorative solution  
 for both residential and  
 commercial applications.

Sensor and Emergency  
 options.



Photometric  
 Diagram

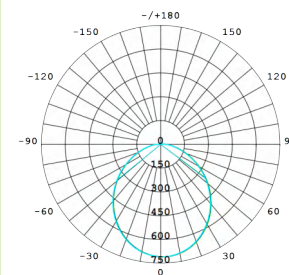

Unit: cd  
 CO/180 120.0deg  
 C90/270 120.0deg

## KEY INFORMATION

Lumen Output	<b>1050 / 2050 lm</b>
Input Power	<b>10W/20W(Watt-selectable)</b>
Hole Cutout Size	<b>N/A</b>
Install	<b>SURFACE MOUNT</b>
Dimming Options	<b>NON-DIMMABLE</b>
Fitting Colour	<b>BLACK/White</b>
Warranty	<b>5 yr</b>
IP Rating	<b>IP66</b>
Ik Rating	<b>IK10</b>
IC Rating	<b>N/A</b>

## PHOTOMETRIC

Efficacy	<b>100-110 lm/W</b>
LED	<b>SMD</b>
CCT	<b>3000/4000/5000K (CCT-Selectable)</b>
CRI	<b>&gt;80</b>
Beam Angle	<b>120°</b>

## ELECTRICAL

Driver	<b>Integral</b>
Supply Input	<b>220-240V,50/60Hz</b>
Power Factor	<b>&gt;0.9</b>
Useful life @Ta 25°(L70)	<b>50,000hrs</b>

## CONSTRUCTION

Housing	<b>Aluminium</b>
Optics	<b>Polycarbonate Diffuser</b>
Adjustable Angle	<b>N/A</b>
Fixings/Hardware	<b>Mounting Screws</b>
Connection Type	<b>Terminal Block</b>
Total Weight	<b>2.0KG</b>
Dimensions	<b>270x270x85mm</b>
Operating Ambient Temp.	<b>-20 to 45°C</b>
Electrical Classification	<b>Class 1</b>

## Dusk

DSK-1628

a robust LED Wallpack constructed with Aluminium body and Polycarbonate opal diffuser providing decorative solution for both residential and commercial applications

\*Suitable for use in indoor and outdoor parking areas, tunnels, walkways, building entrances, loading bays, fire assembly points

\*Die cast aluminium housing providing optimal heat dissipation and high resistance to weather conditions

\*Tritone colour selectable, Multi-watts selectable

\*High impact rating of IK06

\*High efficacy of 105lm/W

\*Wide operating ambient temperature range of -25°C to 40°C

\*Suitable for switching by PIR, Microwave or Photocell

\*3 hour emergency version available through Conversions



### KEY INFORMATION

Lumen Output	1680lm-2940lm
Input Power	16W/20W/24W/28W (Watt-select)
Hole Cutout Size	N/A
Install	<b>SURFACE MOUNT</b>
Dimming Options	<b>NON-DIMMABLE</b>
Fitting Colour	<b>BLACK</b>
Warranty	5 yr
IP Rating	<b>IP65</b>
Ik Rating	<b>IK06</b>
IC Rating	<b>N/A</b>

### PHOTOMETRIC

Efficacy	105 lm/W
LED	<b>SMD</b>
CCT	<b>3000/4000/5000K (CCT-Selectable)</b>
CRI	<b>&gt;80</b>
Beam Angle	<b>120°</b>

### ELECTRICAL

Driver	<b>Integral</b>
Supply Input	<b>220-240V,50/60Hz</b>
Power Factor	<b>&gt;0.9</b>
Useful life @Ta 25°(L70)	<b>50,000hrs</b>

### CONSTRUCTION

Housing	<b>Die Casting aluminum</b>
Optics	<b>Polycarbonate Diffuser</b>
Adjustable Angle	<b>N/A</b>
Fixings/Hardware	<b>Mounting Screws</b>
Connection Type	<b>Terminal Block</b>
Total Weight	<b>2.3KG</b>
Dimensions	<b>264x310x118mm</b>
Operating Ambient Temp.	<b>-20 to 45°C</b>
Electrical Classification	<b>Class 1</b>

## Dusk

DSK-3052

a robust LED Wallpack constructed with Aluminium body and Polycarbonate opal diffuser providing decorative solution for both residential and commercial applications

\*Suitable for use in indoor and outdoor parking areas, tunnels, walkways, building entrances, loading bays, fire assembly points

\*Die cast aluminium housing providing optimal heat dissipation and high resistance to weather conditions

\*Tritone colour selectable, Multi-watts selectable

\*High impact rating of IK06

\*High efficacy of 105lm/W

\*Wide operating ambient temperature range of -25°C to 40°C

\*Suitable for switching by PIR, Microwave or Photocell

\*3 hour emergency version available through Conversions



### KEY INFORMATION

Lumen Output	3150lm-5460lm
Input Power	30W/35W/45W/52W (Watt-select)
Hole Cutout Size	N/A
Install	<b>SURFACE MOUNT</b>
Dimming Options	<b>NON-DIMMABLE</b>
Fitting Colour	<b>BLACK</b>
Warranty	5 yr
IP Rating	<b>IP65</b>
Ik Rating	<b>IK06</b>
IC Rating	<b>N/A</b>

### PHOTOMETRIC

Efficacy	105 lm/W
LED	<b>SMD</b>
CCT	<b>3000/4000/5000K (CCT-Selectable)</b>
CRI	<b>&gt;80</b>
Beam Angle	<b>120°</b>

### ELECTRICAL

Driver	<b>Integral</b>
Supply Input	<b>220-240V,50/60Hz</b>
Power Factor	<b>&gt;0.9</b>
Useful life @Ta 25°(L70)	<b>50,000hrs</b>

### CONSTRUCTION

Housing	<b>Die Casting aluminum</b>
Optics	<b>Polycarbonate Diffuser</b>
Adjustable Angle	<b>N/A</b>
Fixings/Hardware	<b>Mounting Screws</b>
Connection Type	<b>Terminal Block</b>
Total Weight	<b>2.6KG</b>
Dimensions	<b>270x300x180mm</b>
Operating Ambient Temp.	<b>-20 to 45°C</b>
Electrical Classification	<b>Class 1</b>

# Drome

DRM-70120

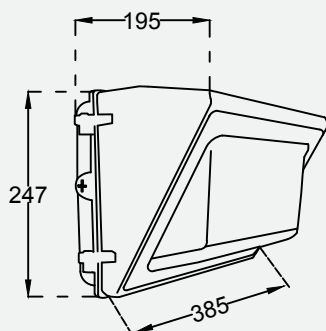

The perfect combination of traditional looking design and industry defining selectable features, making it the ideal solution for commercial and residential applications.

\*Die cast aluminium housing providing optimal heat dissipation and high resistance to weather conditions

\*Tritone colour selectable, Multi-watts selectable

\*IP65 waterproof rating

\*High efficacy of 105lm/W

\*Wide operating ambient temperature range of -25°C to 40°C

\*Built-In Photocell

\*Five years warranty

## KEY INFORMATION

Lumen Output	7350 lm/12600 lm
Input Power	70W/120W (Watt-select)
Hole Cutout Size	N/A
Install	<b>SURFACE MOUNT</b>
Dimming Options	<b>NON-DIMMABLE</b>
Fitting Colour	<b>Dark bronze polyester powder</b>
Warranty	<b>5 yr</b>
IP Rating	<b>IP65</b>
Ik Rating	<b>IK06</b>
IC Rating	<b>N/A</b>

## PHOTOMETRIC

Efficacy	105 lm/W
LED	<b>SMD</b>
CCT	<b>3000/4000/5000K (CCT-Selectable)</b>
CRI	<b>&gt;80</b>
Beam Angle	<b>120°</b>

## ELECTRICAL

Driver	<b>Integral</b>
Supply Input	<b>100 -240V,50/60Hz</b>
Power Factor	<b>&gt;0.9</b>
Useful life @Ta 25°(L70)	<b>50,000hrs</b>

## CONSTRUCTION

Housing	<b>Die Casting aluminum</b>
Optics	<b>Polycarbonate Diffuser</b>
Adjustable Angle	<b>N/A</b>
Fixings/Hardware	<b>Mounting Screws</b>
Connection Type	<b>Terminal Block</b>
Total Weight	<b>3.0KG</b>
Dimensions	<b>385 x247 x195 mm</b>
Operating Ambient Temp.	<b>-20 to 45°C</b>
Electrical Classification	<b>Class 1</b>

# Nexus

NES100

3-CCT(3K/4K/5K) and  
 3-Watts (30W/60W/100W)  
 in one fitting

Ultra-efficient  
 offset bracket ,  
 super slim body,  
 LEDFlood light

Perfect for any exterior space  
 from residential small  
 wattage designs through to  
 high performance commercial  
 applications

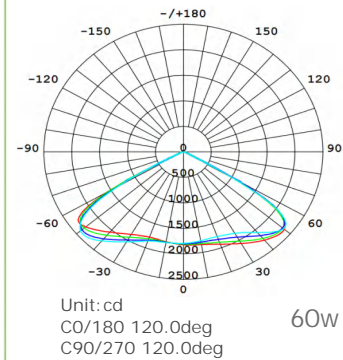
 Photometric  
 Diagram

## KEY INFORMATION

Lumen Output	3,000-10,000lm
Input Power	30W/60W/100W
Hole Cutout Size	N/A
Install	N/A
Dimming Options	NON-DIMMABLE
Fitting Colour	BLACK
Warranty	3 yr
IP Rating	IP66
Ik Rating	IK08
IC Rating	N/A

## PHOTOMETRIC

Efficacy	100 lm/W
LED	SMD
CCT	3000/4000/5000K
CRI	>80
Beam Angle	120°

## ELECTRICAL

Driver	Integral
Supply Input	200-240V,50/60Hz
Power Factor	>0.9
Useful life @Ta 25°(L70)	50,000hrs
Emergency time	N/A
Sensor	N/A

## CONSTRUCTION

Housing	Aluminium
Optics	Tempered Glass
Adjustable Angle	180°
Fixings/Hardware	Mounting Screws
Connection Type	N/A
Total Weight	2.0KG
Dimensions	250 x167 x42 mm
Operating Ambient Temp.	-20 to 45°C
Electrical Classification	Class 1

# Nexus

NES200

3-CCT(3K/4K/5K) and  
 3-Watts (120W/150W/200W)  
 in one fitting

Ultra-efficient  
 offset bracket ,  
 super slim body,  
 LEDFlood light

Perfect for any exterior space  
 from residential small  
 wattage designs through to  
 high performance commercial  
 applications

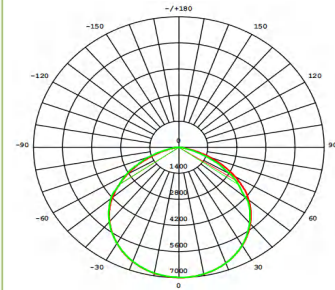
 Photometric  
 Diagram

Unit: cd  
 C0/180 120.0deg  
 C90/270 120.0deg

## KEY INFORMATION

Lumen Output	12,000-20,000lm
Input Power	120W/150W/200W
Hole Cutout Size	N/A
Install	N/A
Dimming Options	NON-DIMMABLE
Fitting Colour	BLACK
Warranty	3 yr
IP Rating	IP66
Ik Rating	IK08
IC Rating	N/A

## PHOTOMETRIC

Efficacy	100 lm/W
LED	SMD
CCT	3000/4000/5000K
CRI	>80
Beam Angle	120°

## ELECTRICAL

Driver	Integral
Supply Input	200-240V,50/60Hz
Power Factor	>0.9
Useful life @Ta 25°(L70)	50,000hrs
Emergency time	N/A
Sensor	N/A

## CONSTRUCTION

Housing	Aluminium
Optics	Tempered Glass
Adjustable Angle	180°
Fixings/Hardware	Mounting Screws
Connection Type	N/A
Total Weight	3.9 KGS
Dimensions	353 x305 x58 mm
Operating Ambient Temp.	-20 to 45°C
Electrical Classification	Class 1

# Lumos

LUS100

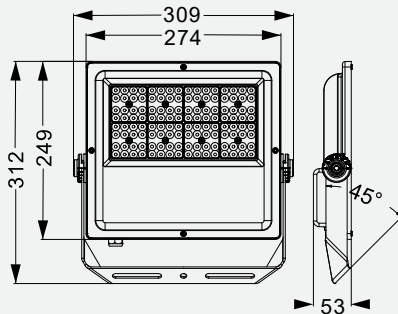

Ultra-efficient  
offset bracket ,  
super slim body,  
LED Flood light

Perfect for any exterior space  
from residential small  
wattage designs through to  
high performance commercial  
applications

Accessories  
Optional Twin Bracket

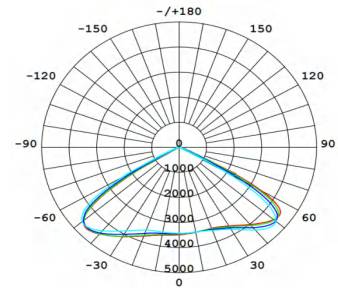
 Photometric  
Diagram

Unit: cd  
 C0/180 120.0deg  
 C90/270 120.0deg

## KEY INFORMATION

Lumen Output	13,000 lm
Input Power	100W
Hole Cutout Size	N/A
Install	N/A
Dimming Options	NON-DIMMABLE
Fitting Colour	BLACK
Warranty	5 yr
IP Rating	IP66
Ik Rating	IK08
IC Rating	N/A

## PHOTOMETRIC

Efficacy	130 lm/W
LED	SMD
CCT	3000/4000/5000K
CRI	>80
Beam Angle	90°/120°/Asymmetric

## ELECTRICAL

Driver	Integral
Supply Input	90-305V,50/60Hz
Power Factor	>0.95
Useful life @Ta 25°(L70)	50,000hrs
Emergency time	N/A
Sensor	N/A

## CONSTRUCTION

Housing	Aluminium
Optics	Tempered Glass
Adjustable Angle	180°
Fixings/Hardware	Mounting Screws
Connection Type	N/A
Total Weight	4.6KG
Dimensions	309x312x53mm
Operating Ambient Temp.	-20 to 45°C
Electrical Classification	Class 1



# Lumos

LUS200

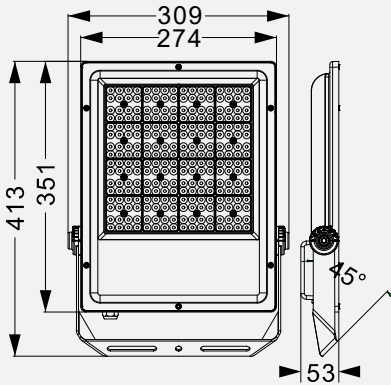

Ultra-efficient  
offset bracket ,  
super slim body,  
LED Flood light

Perfect for any exterior space  
from residential small  
wattage designs through to  
high performance commercial  
applications

Accessories  
Optional Twin Bracket



Photometric Diagram

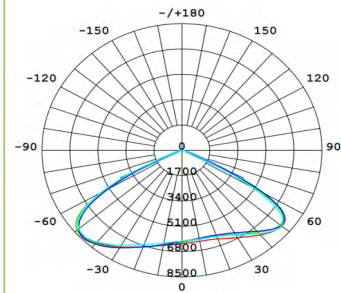

Unit: cd  
 CO/180 120.0deg  
 C90/270 120.0deg

## KEY INFORMATION

Lumen Output	26,000 lm
Input Power	200W
Hole Cutout Size	N/A
Install	N/A
Dimming Options	NON-DIMMABLE
Fitting Colour	BLACK
Warranty	5 yr
IP Rating	IP66
Ik Rating	IK08
IC Rating	N/A

## PHOTOMETRIC

Efficacy	130 lm/W
LED	SMD
CCT	3000/4000/5000K
CRI	>80
Beam Angle	90°/120°/Asymmetric

## ELECTRICAL

Driver	Integral
Supply Input	90-305V,50/60Hz
Power Factor	>0.95
Useful life @Ta 25°(L70)	50,000hrs
Emergency time	N/A
Sensor	N/A

## CONSTRUCTION

Housing	Aluminium
Optics	Tempered Glass
Adjustable Angle	180°
Fixings/Hardware	Mounting Screws
Connection Type	N/A
Total Weight	5.7 KG
Dimensions	309x413x53mm
Operating Ambient Temp.	-20 to 45°C
Electrical Classification	Class 1

# Lumos

LUS300

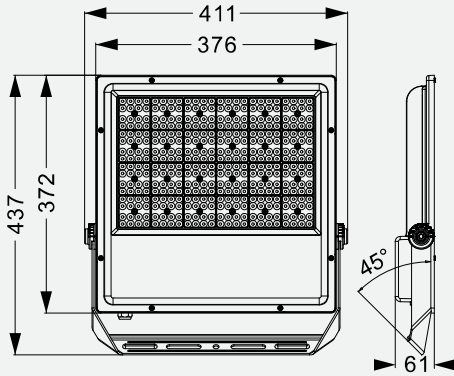

Ultra-efficient  
offset bracket ,  
super slim body,  
LED Flood light

Perfect for any exterior space  
from residential small  
wattage designs through to  
high performance commercial  
applications

Accessories  
Optional Twin Bracket



Photometric Diagram Unit: cd

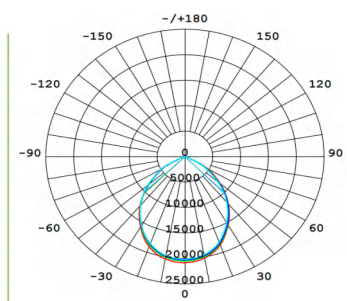

C0/180 90.0deg C90/270 90.0deg

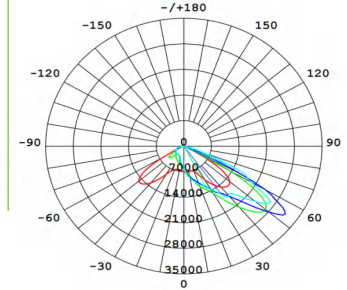

Asymmetric

C0/180 123.4deg C90/270 36.5deg

## KEY INFORMATION

Lumen Output	39,000 lm
Input Power	300W
Hole Cutout Size	N/A
Install	N/A
Dimming Options	NON-DIMMABLE
Fitting Colour	BLACK
Warranty	5 yr
IP Rating	IP66
Ik Rating	IK08
IC Rating	N/A

## PHOTOMETRIC

Efficacy	130 lm/W
LED	SMD
CCT	3000/4000/5000K
CRI	>80
Beam Angle	90°/120°/Asymmetric

## ELECTRICAL

Driver	Integral
Supply Input	90-305V,50/60Hz
Power Factor	>0.95
Useful life @Ta 25°(L70)	50,000hrs
Emergency time	N/A
Sensor	N/A

## CONSTRUCTION

Housing	Aluminium
Optics	Tempered Glass
Adjustable Angle	180°
Fixings/Hardware	Mounting Screws
Connection Type	N/A
Total Weight	8.5 KG
Dimensions	411x437x61mm
Operating Ambient Temp.	-20 to 45°C
Electrical Classification	Class 1

**lumieVO**  
LIGHT EVOLVING

## Lumos

LUS400

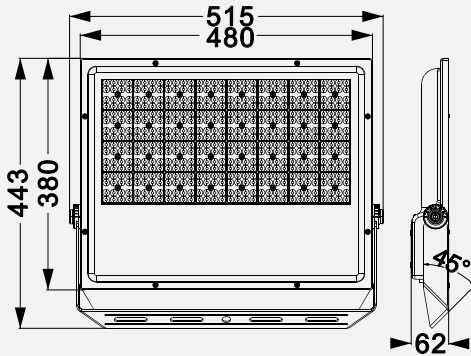

Ultra-efficient  
offset bracket ,  
super slim body,  
LED Flood light

Perfect for any exterior space  
from residential small  
wattage designs through to  
high performance commercial  
applications

Accessories  
Optional Twin Bracket



Photometric Diagram Unit:cd

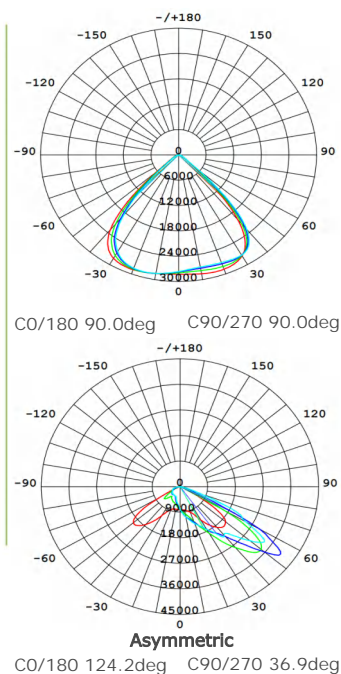

### KEY INFORMATION

Lumen Output	52,000 lm
Input Power	400W
Hole Cutout Size	N/A
Install	N/A
Dimming Options	NON-DIMMABLE
Fitting Colour	BLACK
Warranty	5 yr
IP Rating	IP66
Ik Rating	IK08
IC Rating	N/A

### PHOTOMETRIC

Efficacy	130 lm/W
LED	SMD
CCT	3000/4000/5000K
CRI	>80
Beam Angle	90°/120°/Asymmetric

### ELECTRICAL

Driver	Integral
Supply Input	90-305V,50/60Hz
Power Factor	>0.95
Useful life @Ta 25°(L70)	50,000hrs
Emergency time	N/A
Sensor	N/A

### CONSTRUCTION

Housing	Aluminium
Optics	Tempered Glass
Adjustable Angle	180°
Fixings/Hardware	Mounting Screws
Connection Type	N/A
Total Weight	11.0 KG
Dimensions	515x443x62mm
Operating Ambient Temp.	-20 to 45°C
Electrical Classification	Class 1

# Luxor

LXR50

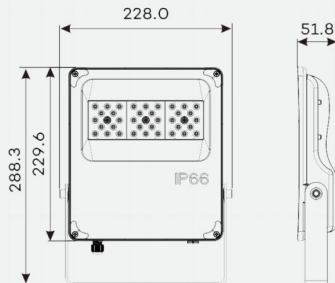

Ultra-efficient  
offset bracket ,  
super slim body,  
LED Flood light

Perfect for any exterior space  
from residential small  
wattage designs through to  
high performance commercial  
applications

Accessories  
Optional Twin Bracket



Photometric Diagram

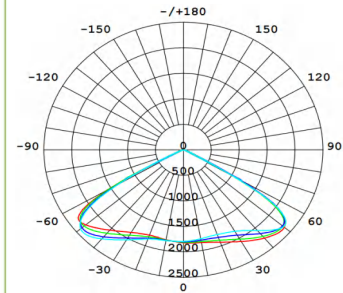

Unit: cd  
 CO/180 120.0deg  
 C90/270 120.0deg

## KEY INFORMATION

Lumen Output	<b>6500 lm</b>
Input Power	<b>50W</b>
Hole Cutout Size	<b>N/A</b>
Install	<b>N/A</b>
Dimming Options	<b>NON-DIMMABLE</b>
Fitting Colour	<b>BLACK</b>
Warranty	<b>5 yr</b>
IP Rating	<b>IP66</b>
Ik Rating	<b>IK08</b>
IC Rating	<b>N/A</b>

## PHOTOMETRIC

Efficacy	<b>130 lm/W</b>
LED	<b>SMD</b>
CCT	<b>3000/4000/5000K</b>
CRI	<b>&gt;80</b>
Beam Angle	<b>90°/120°/Asymmetric</b>

## ELECTRICAL

Driver	<b>Integral</b>
Supply Input	<b>90-305V,50/60Hz</b>
Power Factor	<b>&gt;0.95</b>
Useful life @Ta 25°(L70)	<b>50,000hrs</b>
Emergency time	<b>N/A</b>
Sensor	<b>N/A</b>

## CONSTRUCTION

Housing	<b>Aluminium</b>
Optics	<b>Tempered Glass</b>
Adjustable Angle	<b>180°</b>
Fixings/Hardware	<b>Mounting Screws</b>
Connection Type	<b>N/A</b>
Total Weight	<b>3.0KG</b>
Dimensions	<b>288.3x228.0x51.8mm</b>
Operating Ambient Temp.	<b>-20 to 45°C</b>
Electrical Classification	<b>Class 1</b>

# Luxor

LXR100

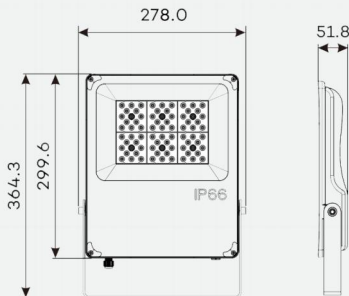

Ultra-efficient  
offset bracket ,  
super slim body,  
LED Flood light

Perfect for any exterior space  
from residential small  
wattage designs through to  
high performance commercial  
applications

Accessories  
Optional Twin Bracket



Photometric Diagram

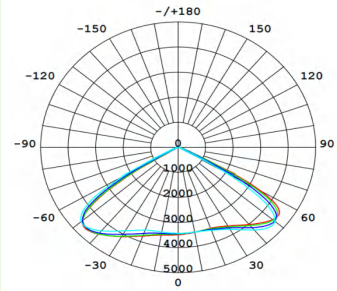

Unit: cd  
CO/180 120.0deg  
C90/270 120.0deg

## KEY INFORMATION

Lumen Output	13,000 lm
Input Power	100W
Hole Cutout Size	N/A
Install	N/A
Dimming Options	NON-DIMMABLE
Fitting Colour	BLACK
Warranty	5 yr
IP Rating	IP66
Ik Rating	IK08
IC Rating	N/A

## PHOTOMETRIC

Efficacy	130 lm/W
LED	SMD
CCT	3000/4000/5000K
CRI	>80
Beam Angle	90°/120°/Asymmetric

## ELECTRICAL

Driver	Integral
Supply Input	90-305V,50/60Hz
Power Factor	>0.95
Useful life @Ta 25°(L70)	50,000hrs
Emergency time	N/A
Sensor	N/A

## CONSTRUCTION

Housing	Aluminium
Optics	Tempered Glass
Adjustable Angle	180°
Fixings/Hardware	Mounting Screws
Connection Type	N/A
Total Weight	5.2KG
Dimensions	364.3x278.0x51.8mm
Operating Ambient Temp.	-20 to 45°C
Electrical Classification	Class 1

# Luxor

LXR150

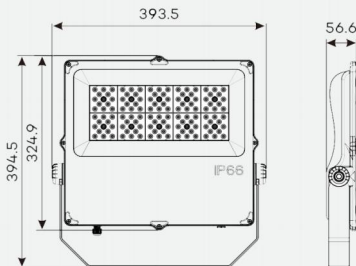

Ultra-efficient  
offset bracket ,  
super slim body,  
LED Flood light

Perfect for any exterior space  
from residential small  
wattage designs through to  
high performance commercial  
applications

Accessories  
Optional Twin Bracket



Photometric  
Diagram

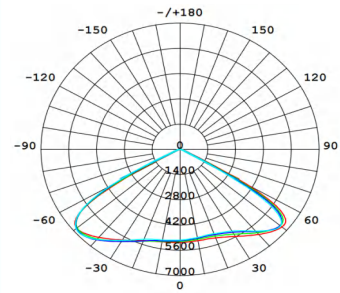

Unit: cd  
C0/180 120.0deg  
C90/270 120.0deg

## KEY INFORMATION

Lumen Output	<b>19,500 lm</b>
Input Power	<b>150W</b>
Hole Cutout Size	<b>N/A</b>
Install	<b>N/A</b>
Dimming Options	<b>NON-DIMMABLE</b>
Fitting Colour	<b>BLACK</b>
Warranty	<b>5 yr</b>
IP Rating	<b>IP66</b>
Ik Rating	<b>IK08</b>
IC Rating	<b>N/A</b>

## PHOTOMETRIC

Efficacy	<b>130 lm/W</b>
LED	<b>SMD</b>
CCT	<b>3000/4000/5000K</b>
CRI	<b>&gt;80</b>
Beam Angle	<b>90°/120°/Asymmetric</b>

## ELECTRICAL

Driver	<b>Integral</b>
Supply Input	<b>90-305V,50/60Hz</b>
Power Factor	<b>&gt;0.95</b>
Useful life @Ta 25°(L70)	<b>50,000hrs</b>
Emergency time	<b>N/A</b>
Sensor	<b>N/A</b>

## CONSTRUCTION

Housing	<b>Aluminium</b>
Optics	<b>Tempered Glass</b>
Adjustable Angle	<b>180°</b>
Fixings/Hardware	<b>Mounting Screws</b>
Connection Type	<b>N/A</b>
Total Weight	<b>6.6KG</b>
Dimensions	<b>394.5x393.5x56.6mm</b>
Operating Ambient Temp.	<b>-20 to 45°C</b>
Electrical Classification	<b>Class 1</b>

## Luxor

LXR200

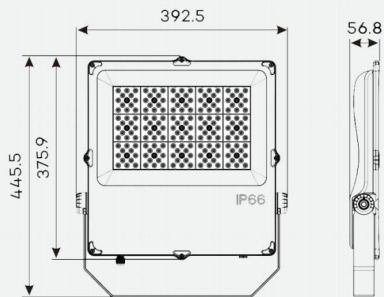

Ultra-efficient  
offset bracket ,  
super slim body,  
LED Flood light

Perfect for any exterior space  
from residential small  
wattage designs through to  
high performance commercial  
applications

Accessories  
Optional Twin Bracket



Photometric  
Diagram

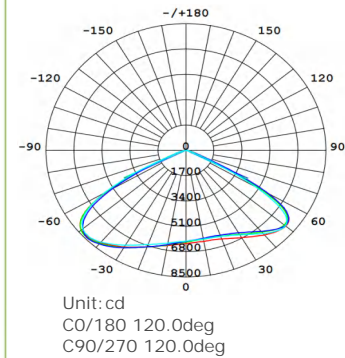

### KEY INFORMATION

Lumen Output	26,000 lm
Input Power	200W
Hole Cutout Size	N/A
Install	N/A
Dimming Options	NON-DIMMABLE
Fitting Colour	BLACK
Warranty	5 yr
IP Rating	IP66
Ik Rating	IK08
IC Rating	N/A

### PHOTOMETRIC

Efficacy	130 lm/W
LED	SMD
CCT	3000/4000/5000K
CRI	>80
Beam Angle	90°/120°/Asymmetric

### ELECTRICAL

Driver	Integral
Supply Input	90-305V,50/60Hz
Power Factor	>0.95
Useful life @Ta 25°(L70)	50,000hrs
Emergency time	N/A
Sensor	N/A

### CONSTRUCTION

Housing	Aluminium
Optics	Tempered Glass
Adjustable Angle	180°
Fixings/Hardware	Mounting Screws
Connection Type	N/A
Total Weight	7.3 KG
Dimensions	445.5x392.5x56.8mm
Operating Ambient Temp.	-20 to 45°C
Electrical Classification	Class 1

**lumieVO**  
LIGHT EVOLVING

## Luxor

LXR300

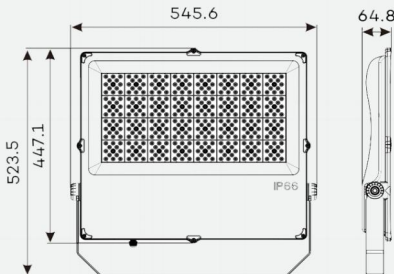

Ultra-efficient  
offset bracket ,  
super slim body,  
LED Flood light

Perfect for any exterior space  
from residential small  
wattage designs through to  
high performance commercial  
applications

Accessories  
Optional Twin Bracket



Photometric Diagram Unit: cd

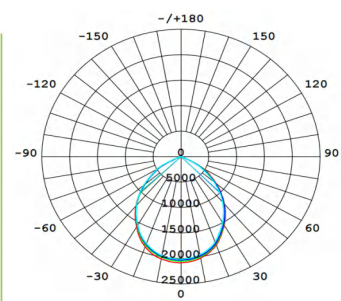

C0/180 90.0deg C90/270 90.0deg

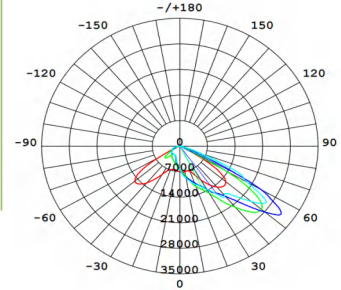

Asymmetric

C0/180 123.4deg C90/270 36.5deg

### KEY INFORMATION

Lumen Output	<b>39,000 lm</b>
Input Power	<b>300W</b>
Hole Cutout Size	<b>N/A</b>
Install	<b>N/A</b>
Dimming Options	<b>NON-DIMMABLE</b>
Fitting Colour	<b>BLACK</b>
Warranty	<b>5 yr</b>
IP Rating	<b>IP66</b>
Ik Rating	<b>IK08</b>
IC Rating	<b>N/A</b>

### PHOTOMETRIC

Efficacy	<b>130 lm/W</b>
LED	<b>SMD</b>
CCT	<b>3000/4000/5000K</b>
CRI	<b>&gt;80</b>
Beam Angle	<b>90°/120°/Asymmetric</b>

### ELECTRICAL

Driver	<b>Integral</b>
Supply Input	<b>90-305V,50/60Hz</b>
Power Factor	<b>&gt;0.95</b>
Useful life @Ta 25°(L70)	<b>50,000hrs</b>
Emergency time	<b>N/A</b>
Sensor	<b>N/A</b>

### CONSTRUCTION

Housing	<b>Aluminium</b>
Optics	<b>Tempered Glass</b>
Adjustable Angle	<b>180°</b>
Fixings/Hardware	<b>Mounting Screws</b>
Connection Type	<b>N/A</b>
Total Weight	<b>11.5 KG</b>
Dimensions	<b>523.5x545.6x64.8mm</b>
Operating Ambient Temp.	<b>-20 to 45°C</b>
Electrical Classification	<b>Class 1</b>



**lumieVO**  
LIGHT EVOLVING

## Luxor

LXR400

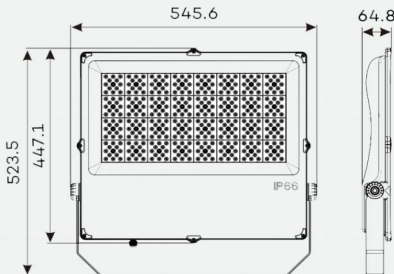

Ultra-efficient  
offset bracket ,  
super slim body,  
LED Flood light

Perfect for any exterior space  
from residential small  
wattage designs through to  
high performance commercial  
applications

Accessories  
Optional Twin Bracket



Photometric Diagram Unit:cd

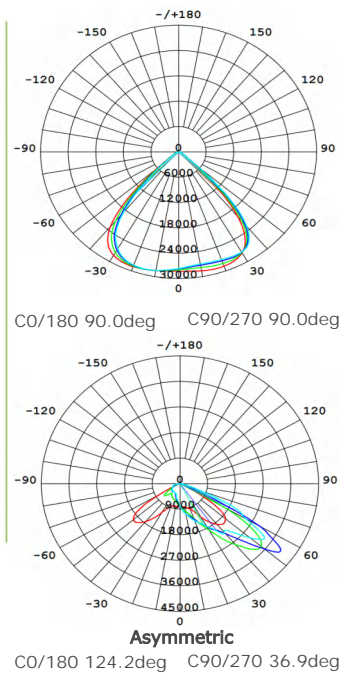

### KEY INFORMATION

Lumen Output	52,000 lm
Input Power	400W
Hole Cutout Size	N/A
Install	N/A
Dimming Options	NON-DIMMABLE
Fitting Colour	BLACK
Warranty	5 yr
IP Rating	IP66
Ik Rating	IK08
IC Rating	N/A

### PHOTOMETRIC

Efficacy	130 lm/W
LED	SMD
CCT	3000/4000/5000K
CRI	>80
Beam Angle	90°/120°/Asymmetric

### ELECTRICAL

Driver	Integral
Supply Input	90-305V,50/60Hz
Power Factor	>0.95
Useful life @Ta 25°(L70)	50,000hrs
Emergency time	N/A
Sensor	N/A

### CONSTRUCTION

Housing	Aluminium
Optics	Tempered Glass
Adjustable Angle	180°
Fixings/Hardware	Mounting Screws
Connection Type	N/A
Total Weight	12.0 KG
Dimensions	523.5x545.6x64.8mm
Operating Ambient Temp.	-20 to 45°C
Electrical Classification	Class 1

**lumieVO**  
LIGHT EVOLVING

## Gaix

Gax500

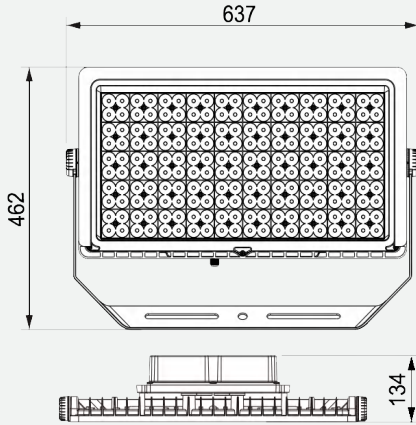

### Symmetrical or asymmetrical, Robust Gaix LED Flood light

Ideal for harsh conditions, with superior housing made of LM6 grade die-cast aluminium, in addition to a chromated and powder-coated black finish

#### Accessories

Optional Hood/Twin Bracket



Photometric Diagram Unit:cd

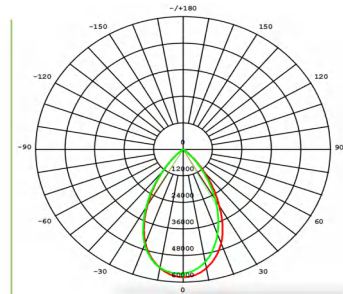

C0/180 60.0deg C90/270 60.0deg

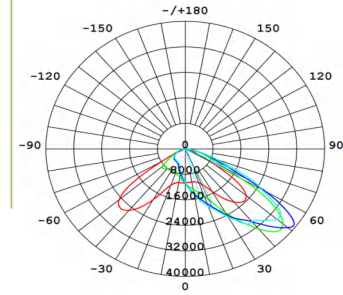

Asymmetric

C0/180 124.6deg C90/270 49.3deg

### KEY INFORMATION

Lumen Output	70,000 lm
Input Power	500W
Hole Cutout Size	N/A
Install	N/A
Dimming Options	NON-DIMMABLE
Fitting Colour	BLACK
Warranty	5 yr
IP Rating	IP66
Ik Rating	IK08
IC Rating	N/A

### PHOTOMETRIC

Efficacy	140 lm/W
LED	SMD
CCT	3000/4000/5000K
CRI	>80
Beam Angle	60°/Asymmetric

### ELECTRICAL

Driver	Integral
Supply Input	90-305V,50/60Hz
Power Factor	>0.95
Useful life @Ta 25°(L70)	50,000hrs
Emergency time	N/A
Sensor	N/A

### CONSTRUCTION

Housing	Aluminium
Optics	Tempered Glass
Adjustable Angle	180°
Fixings/Hardware	Mounting Screws
Connection Type	N/A
Total Weight	12.0 KG
Dimensions	531x128x377mm
Operating Ambient Temp.	-20 to 45°C
Electrical Classification	Class 1

# Astro

Asr600

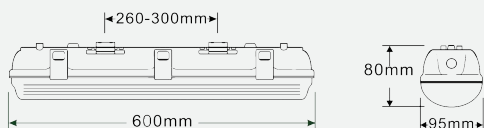

Photometric Diagram

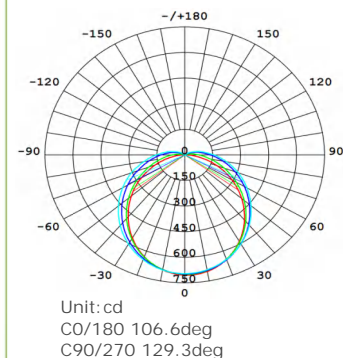

The ability to select your preferred lumen output/wattage within one light fitting.

These are the perfect option when simple functionality is required. Rear and side entry options for easy linking and conduit entry. Combined diffuser and gear tray lead to exceptionally fast fit off. Vandal resistant latches can be secured to stop any tampering. 3 Colour selection with a fixed power driver.

## KEY INFORMATION

Lumen Output	13,00 lm/26,00 lm
Input Power	10W/20W ( Watt-select )
Hole Cutout Size	N/A
Install	N/A
Dimming Options	NON-DIMMABLE
Fitting Colour	Grey base
Warranty	5 yr
IP Rating	IP65
Ik Rating	IK08
IC Rating	N/A

## PHOTOMETRIC

Efficacy	130 lm/W
LED	SMD
CCT	3000/4000/5000K(CCT-Select)
CRI	>80
Beam Angle	120°

## ELECTRICAL

Driver	Integral
Supply Input	200-240V,50/60Hz
Power Factor	>0.95
Useful life @Ta 25°(L70)	50,000hrs
Emergency time	180mins(Emergency Option)
Sensor	Setting via Remote(Sensor Option)

## CONSTRUCTION

Housing	Polycarbonate
Optics	Polycarbonate
Adjustable Angle	N/A
Fixings/Hardware	Mounting Screws
Connection Type	N/A
Total Weight	0.82 KG
Dimensions	600x95x80mm
Operating Ambient Temp.	-20 to 45°C
Electrical Classification	Class 1

# Astro

Asr1200

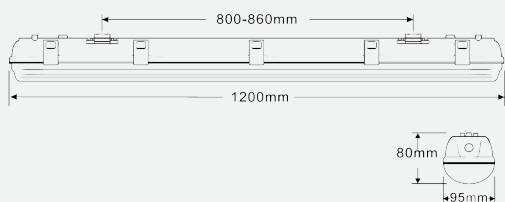

The ability to select your preferred lumen output/wattage within one light fitting.

These are the perfect option when simple functionality is required. Rear and side entry options for easy linking and conduit entry. Combined diffuser and gear tray lead to exceptionally fast fit off. Vandal resistant latches can be secured to stop any tampering. 3 Colour selection with a fixed power driver.



Photometric Diagram

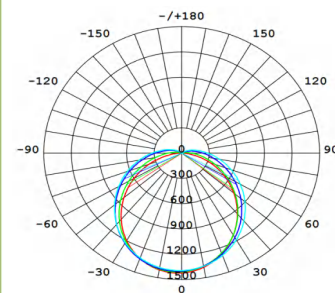

Unit: cd  
 CO/180 106.4deg  
 C90/270 128.0deg

## KEY INFORMATION

Lumen Output	26,00 lm/52,00 lm
Input Power	20W/40W ( Watt-select )
Hole Cutout Size	N/A
Install	N/A
Dimming Options	NON-DIMMABLE
Fitting Colour	Grey base
Warranty	5 yr
IP Rating	IP65
Ik Rating	IK08
IC Rating	N/A

## PHOTOMETRIC

Efficacy	130 lm/W
LED	SMD
CCT	3000/4000/5000K(CCT-Select)
CRI	>80
Beam Angle	120°

## ELECTRICAL

Driver	Integral
Supply Input	200-240V,50/60Hz
Power Factor	>0.95
Useful life @Ta 25°(L70)	50,000hrs
Emergency time	180mins(Emergency Option)
Sensor	Setting via Remote(Sensor Option)

## CONSTRUCTION

Housing	Polycarbonate
Optics	Polycarbonate
Adjustable Angle	N/A
Fixings/Hardware	Mounting Screws
Connection Type	N/A
Total Weight	1.28 KG
Dimensions	1200x95x80mm
Operating Ambient Temp.	-20 to 45°C
Electrical Classification	Class 1

# Astro

B/G/R/A600

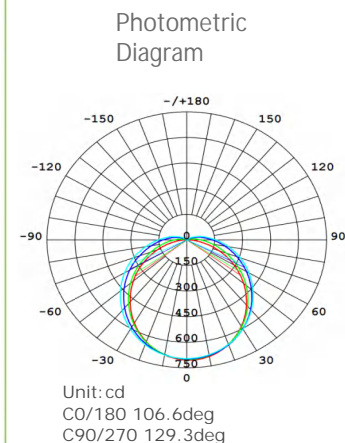
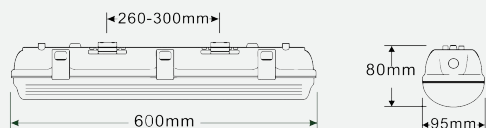

Dual colour selections  
 Blue or Green, Red or  
 Amber Wavelength / CCT

—  
 Blue: 450 – 470 nm,  
 Green: 510 – 530 nm,  
 Amber: 1800 K,  
 Red: 615 – 635 nm

These are the perfect option when simple functionality is required. Rear and side entry options for easy linking and conduit entry. Combined diffuser and gear tray lead to exceptionally fast fit off.

Vandal resistant latches can be secured to stop any tampering.

## KEY INFORMATION

Dual colour	<b>Blue+Green OR Red+Amber</b>
Dual Wattage	<b>10W/20W ( Watt-select</b>
Hole Cutout Size	<b>N/A</b>
Install	<b>N/A</b>
Dimming Options	<b>NON-DIMMABLE</b>
Fitting Colour	<b>Grey base</b>
Warranty	<b>5 yr</b>
IP Rating	<b>IP65</b>
Ik Rating	<b>IK08/IK10</b>
IC Rating	<b>N/A</b>

## PHOTOMETRIC

Blue	<b>450-470nm</b>
Green	<b>510-530nm</b>
Amber	<b>1800K</b>
Red	<b>615-635nm</b>
Beam Angle	<b>120°</b>

## ELECTRICAL

Driver	<b>Integral</b>
Supply Input	<b>200-240V,50/60Hz</b>
Power Factor	<b>&gt;0.95</b>
Useful life @Ta 25°(L70)	<b>50,000hrs</b>
Emergency time	<b>180mins(Emergency Option)</b>
Sensor	<b>Setting via Remote(Sensor Option)</b>

## CONSTRUCTION

Housing	<b>Polycarbonate/Diecasting Alumium</b>
Optics	<b>Polycarbonate</b>
Adjustable Angle	<b>N/A</b>
Fixings/Hardware	<b>Mounting Screws</b>
Connection Type	<b>N/A</b>
Total Weight	<b>0.82 KG</b>
Dimensions	<b>600x95x80mm</b>
Operating Ambient Temp.	<b>-20 to 45°C</b>
Electrical Classification	<b>Class 1</b>

# Astro

B/G/R/A1200

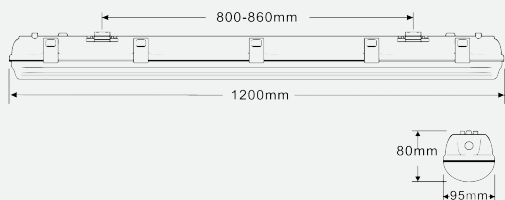

Dual colour selections  
 Blue or Green, Red or Amber  
 Wavelength / CCT –  
 Blue: 450 – 470 nm,  
 Green: 510 – 530 nm,  
 Amber: 1800 K,  
 Red: 615 – 635 nm

These are the perfect option when simple functionality is required. Rear and side entry options for easy linking and conduit entry. Combined diffuser and gear tray lead to exceptionally fast fit off.

Vandal resistant latches can be secured to stop any tampering. Robust polycarbonate/diecasting aluminum body and UV-stabilized polycarbonate diffuser.

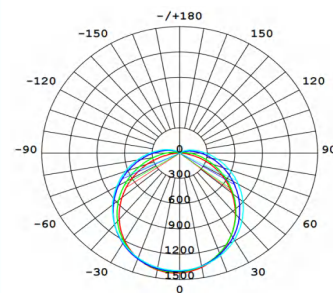

Photometric Diagram

 Unit: cd  
 CO/180 106.4deg  
 C90/270 128.0deg

## KEY INFORMATION

Dual colour	Blue+Green OR Red+Amber
Dual Wattage	20W/40W ( Watt-select )
Hole Cutout Size	N/A
Install	N/A
Dimming Options	NON-DIMMABLE
Fitting Colour	Grey base
Warranty	5 yr
IP Rating	IP65
Ik Rating	IK08/IK10
IC Rating	N/A

## PHOTOMETRIC

Blue	450-470nm
Green	510-530nm
Amber	1800K
Red	615-635nm
Beam Angle	120°

## ELECTRICAL

Driver	Integral
Supply Input	200-240V,50/60Hz
Power Factor	>0.95
Useful life @Ta 25°(L70)	50,000hrs
Emergency time	180mins(Emergency Option)
Sensor	Setting via Remote(Sensor Option)

## CONSTRUCTION

Housing	Polycarbonate/Diecasting Alumium
Optics	Polycarbonate
Adjustable Angle	N/A
Fixings/Hardware	Mounting Screws
Connection Type	N/A
Total Weight	1.28 KG
Dimensions	1200x95x80mm
Operating Ambient Temp.	-20 to 45°C
Electrical Classification	Class 1

# Atlas

Ats600

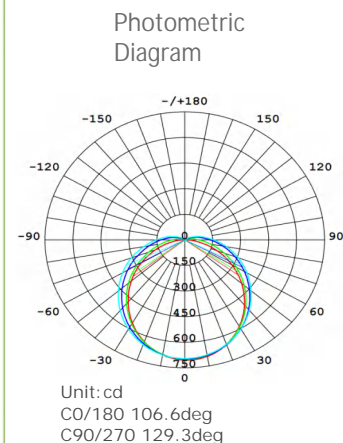
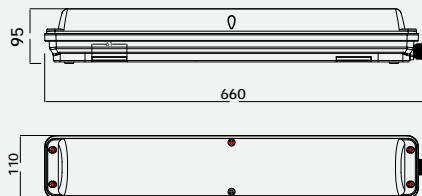

4-Watts Select  
3-CCT Select

a Strong IK10 robust weatherproof batten, built for tough conditions.

The control gear has been designed to be simplified, ultra-efficient and versatile with Lumen Select Technology, 1 luminaire with multiple wattages/lumen outputs in the same traditional body and diffuser making it easier to replace keeping the same appearance through your installation.

## KEY INFORMATION

Lumen Output	3,640-5,200lm
Input Power	28/32/36/40W (Watt-select)
Hole Cutout Size	N/A
Install	Surface mount
Dimming Options	NON-DIMMABLE/DALI/0-10V Dimming
Fitting Colour	Grey base
Warranty	5 yr
IP Rating	IP65
Ik Rating	IK10
IC Rating	N/A

## PHOTOMETRIC

Efficacy	130 lm/W
LED	SMD
CCT	3000/4000/5000K(CCT-Select)
CRI	>80
Beam Angle	120°

## ELECTRICAL

Driver	Integral
Supply Input	200-240V,50/60Hz
Power Factor	>0.95
Useful life @Ta 25°(L70)	50,000hrs
Emergency time	180mins(Emergency Option)
Sensor	Setting via Remote(Sensor Option)

## CONSTRUCTION

Housing	Diecast Alumiumn
Optics	Polycarbonate
Adjustable Angle	N/A
Fixings/Hardware	Mounting Screws
Connection Type	N/A
Total Weight	2.1 KG
Dimensions	660x110x95mm
Operating Ambient Temp.	-20 to 45°C
Electrical Classification	Class 1

# Atlas

Ats1200

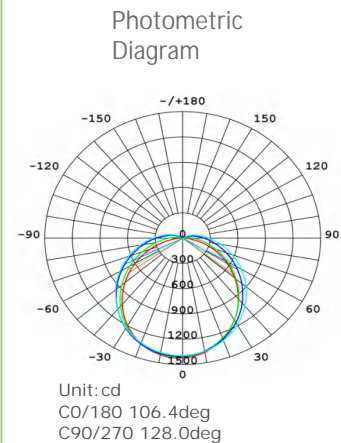
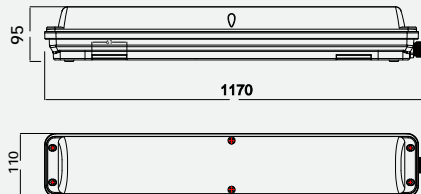

4-Watts Select  
 3-CCT Select

a Strong IK10 robust weatherproof batten, built for tough conditions.

The control gear has been designed to be simplified, ultra-efficient and versatile with Lumen Select Technology, 1 luminaire with multiple wattages/lumen outputs in the same traditional body and diffuser making it easier to replace keeping the same appearance through your installation.

## KEY INFORMATION

Lumen Output	6,240-7,800lm
Input Power	48/52/56/60W (Watt-select)
Hole Cutout Size	N/A
Install	Surface mount
Dimming Options	NON-DIMMABLE/DALI/0-10V Dimming
Fitting Colour	Grey base
Warranty	5 yr
IP Rating	IP65
Ik Rating	IK10
IC Rating	N/A

## PHOTOMETRIC

Efficacy	130 lm/W
LED	SMD
CCT	3000/4000/5000K(CCT-Select)
CRI	>80
Beam Angle	120°

## ELECTRICAL

Driver	Integral
Supply Input	200-240V,50/60Hz
Power Factor	>0.95
Useful life @Ta 25°(L70)	50,000hrs
Emergency time	180mins(Emergency Option)
Sensor	Setting via Remote(Sensor Option)

## CONSTRUCTION

Housing	Diecast Aluminium
Optics	Polycarbonate
Adjustable Angle	N/A
Fixings/Hardware	Mounting Screws
Connection Type	N/A
Total Weight	3.3 KG
Dimensions	1170x110x95mm
Operating Ambient Temp.	-20 to 45°C
Electrical Classification	Class 1



# Selos

Sel600

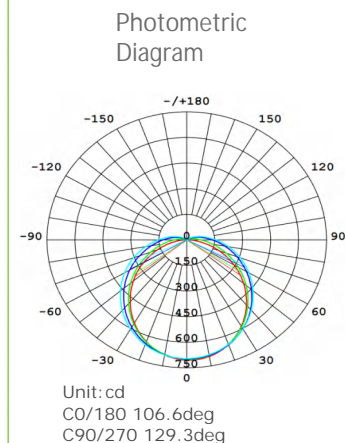
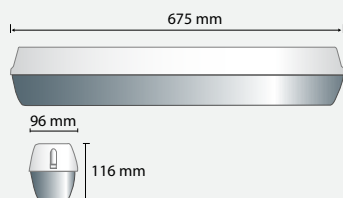

The ability to select your preferred lumen output/wattage within one light fitting.

These are the perfect option when simple functionality is required. Rear and side entry options for easy linking and conduit entry. Combined diffuser and gear tray lead to exceptionally fast fit off. Vandal resistant latches can be secured to stop any tampering. 3 Colour selection with a fixed power driver.

## KEY INFORMATION

Lumen Output	1,100-2,200 lm
Input Power	10W/20W ( Watt-select )
Hole Cutout Size	N/A
Install	N/A
Dimming Options	NON-DIMMABLE
Fitting Colour	Grey base
Warranty	3 yr
IP Rating	IP65
Ik Rating	IK08
IC Rating	N/A

## PHOTOMETRIC

Efficacy	110 lm/W
LED	SMD
CCT	3000/4000/5000K(CCT-Select)
CRI	>80
Beam Angle	120°

## ELECTRICAL

Driver	Integral
Supply Input	200-240V,50/60Hz
Power Factor	>0.95
Useful life @Ta 25°(L70)	50,000hrs
Emergency time	180mins(Emergency Option)
Sensor	Setting via Remote(Sensor Option)

## CONSTRUCTION

Housing	Polycarbonate
Optics	Polycarbonate
Adjustable Angle	N/A
Fixings/Hardware	Mounting Screws
Connection Type	N/A
Total Weight	2.00 KG
Dimensions	675x96x116mm
Operating Ambient Temp.	-20 to 45°C
Electrical Classification	Class 1

# Spoti

Spt90

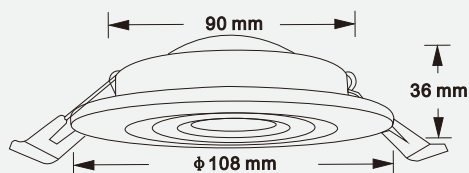

SPOTI multi-function fixed or gimble 60 degree beam reflector style downlight.

A low maintenance solution that is Ideal for residential apartments, foyers, retail, restaurants and clubs where an energy efficient and reliable lamp performance is essential.

Optional  
 Triac/DALI/0-10V Dimming



CCT-Select

## Photometric Diagram

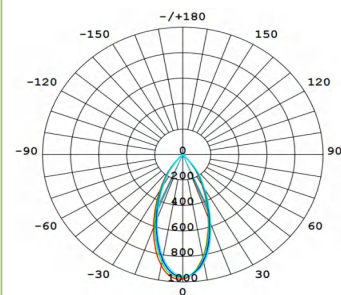

Unit: cd  
 CO/180 45.6deg  
 C90/270 45.6deg

## KEY INFORMATION

Lumen Output	720 lm
Input Power	9W
Hole Cutout Size	90mm
Install	Recessed
Dimming Options	Triac/DALI/0-10V DIMMABLE
Fitting Colour	WHITE
Warranty	5 yr
IP Rating	IP44
Ik Rating	N/A
IC Rating	IC-4

## PHOTOMETRIC

Efficacy	80 lm/W
LED	COB
CCT	3000/4000/5000K(CCT-select)
CRI	>90
Beam Angle	45°/60°

## ELECTRICAL

Driver	External
Supply Input	200-240V,50/60Hz
Power Factor	>0.95
Useful life @Ta 25°(L70)	50,000hrs
Emergency time	N/A
Sensor	N/A

## CONSTRUCTION

Housing	Diecasting Alumnium
Optics	Optics Lens
Adjustable Angle	60°
Fixings/Hardware	N/A
Connection Type	N/A
Total Weight	370 g
Dimensions	φ108xH36mm
Operating Ambient Temp.	-20 to 45°C
Electrical Classification	Class II

# Stellar

Stl90

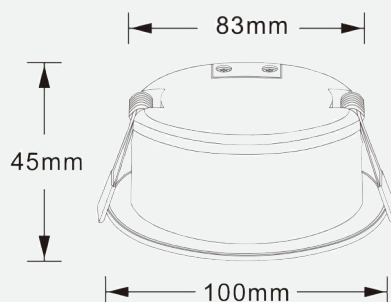

STELLAR multi-function fixed or gimble 60 degree beam reflector style downlight.

A low maintenance solution that is Ideal for residential apartments, foyers, retail, restaurants and clubs where an energy efficient and reliable lamp performance is essential.

Optional  
 Triac/DALI/0-10V Dimming



CCT-Select

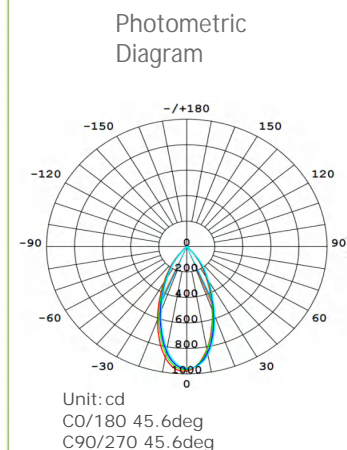

## KEY INFORMATION

Lumen Output	720 lm
Input Power	9W
Hole Cutout Size	90mm
Install	Recessed
Dimming Options	Triac/DALI/0-10V DIMMABLE
Fitting Colour	WHITE
Warranty	5 yr
IP Rating	IP44
Ik Rating	N/A
IC Rating	IC-4

## PHOTOMETRIC

Efficacy	80 lm/W
LED	COB
CCT	3000/4000/5000K(CCT-select)
CRI	>90
Beam Angle	45°/60°

## ELECTRICAL

Driver	External
Supply Input	200-240V,50/60Hz
Power Factor	>0.95
Useful life @Ta 25°(L70)	50,000hrs
Emergency time	N/A
Sensor	N/A

## CONSTRUCTION

Housing	Diecasting Aluminum
Optics	Optics Lens
Adjustable Angle	60°
Fixings/Hardware	N/A
Connection Type	N/A
Total Weight	360 g
Dimensions	φ108xH36mm
Operating Ambient Temp.	-20 to 45°C
Electrical Classification	Class II

# Mars

Mas70

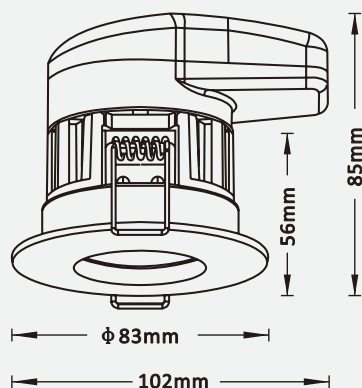

MARS is a multi-function fixed fire rated led downlight.

A low maintenance solution that is Ideal for residential apartments, foyers, retail, restaurants and clubs where an energy efficient and reliable lamp performance is essential.

Optional  
 Triac/DALI/0-10V Dimming



CCT-Select

Photometric Diagram

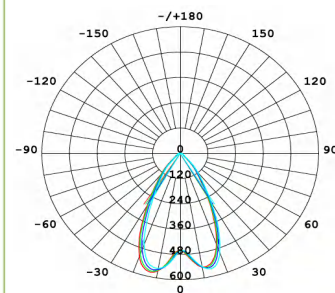

Unit: cd  
 CO/180 62.6deg  
 C90/270 61.6deg

## KEY INFORMATION

Lumen Output	560 lm
Input Power	7W
Hole Cutout Size	70mm
Install	Recessed
Dimming Options	Triac/DALI/0-10V DIMMABLE
Fitting Colour	WHITE
Warranty	5 yr
IP Rating	IP44
Ik Rating	N/A
IC Rating	IC-4

## PHOTOMETRIC

Efficacy	80 lm/W
LED	COB
CCT	2700/3000/4000K(CCT-select)
CRI	>90
Beam Angle	60°

## ELECTRICAL

Driver	Internal
Supply Input	200-240V,50/60Hz
Power Factor	>0.95
Useful life @Ta 25°(L70)	50,000hrs
Emergency time	N/A
Sensor	N/A

## CONSTRUCTION

Housing	Diecasting Aluminum
Optics	Optics Lens
Adjustable Angle	N/A
Fixings/Hardware	N/A
Connection Type	N/A
Total Weight	220 g
Dimensions	φ83xH85mm
Operating Ambient Temp.	-20 to 45°C
Electrical Classification	Class II

# Lumia

Lum70  
 Lum90  
 Lum110  
 Lum140  
 Lum150  
 Lum200

Tritone colour selection allows easy adjustment of colour temperature.

Tritone selectable  
 Built-in dimmable driver (1-100%)  
 IC-4 rating (ta 25°C)  
 Recessed diffuser  
 IP44 from below



CCT-Select

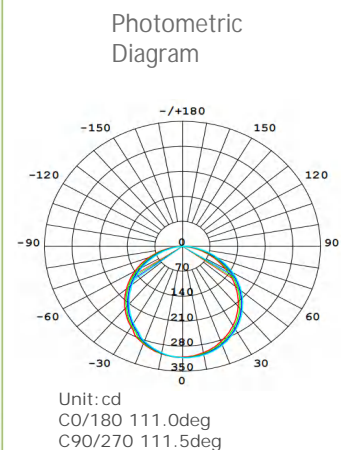

## KEY INFORMATION

Lumen Output	595-2200 lm
Input Power	7w/10w/13w/16w/20w/22w
Hole Cutout Size	70/90/110/140/150/200 mm
Install	Recessed
Dimming Options	Triac DIMMABLE
Fitting Colour	WHITE
Warranty	3 yr
IP Rating	IP44
Ik Rating	N/A
IC Rating	IC-4

## PHOTOMETRIC

Efficacy	95 lm/W
LED	SMD
CCT	3000/4000/5000K(CCT-select)
CRI	>80
Beam Angle	110°

## ELECTRICAL

Driver	Internal
Supply Input	200-240V,50/60Hz
Power Factor	>0.9
Useful life @Ta 25°(L70)	50,000hrs
Emergency time	N/A
Sensor	N/A

## CONSTRUCTION

Housing	Polycarbonate
Optics	Polycarbonate
Adjustable Angle	N/A
Fixings/Hardware	N/A
Connection Type	N/A
Total Weight	N/A
Dimensions	φ92/φ115/φ140/φ170/φ190/φ235mm
Operating Ambient Temp.	-20 to 45°C
Electrical Classification	Class II

# Lumia II

LumII90

10w Low Glare  
 Reflector Down Light  
 with Tritone  
 switchable colour  
 temperature

Tritone selectable  
 Built-in dimmable driver  
 (1-100%)  
 IC-4 rating (ta 25°C)  
 Recessed diffuser  
 IP44  
 60° Beam angle



CCT-Select

Photometric Diagram

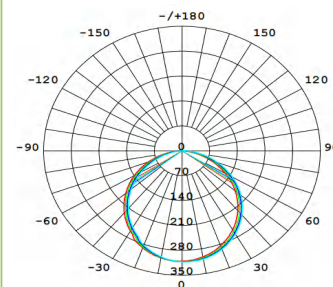

Unit: cd  
 CO/180 60.0deg  
 C90/270 60.0deg

## KEY INFORMATION

Lumen Output	900 lm
Input Power	10W
Hole Cutout Size	90mm
Install	Recessed
Dimming Options	Triac DIMMABLE
Fitting Colour	WHITE
Warranty	3 yr
IP Rating	IP44
Ik Rating	N/A
IC Rating	IC-4

## PHOTOMETRIC

Efficacy	90 lm/W
LED	SMD
CCT	3000/4000/5000K(CCT-select)
CRI	>80
Beam Angle	60 °

## ELECTRICAL

Driver	Internal
Supply Input	200-240V,50/60Hz
Power Factor	>0.9
Useful life @Ta 25°(L70)	50,000hrs
Emergency time	N/A
Sensor	N/A

## CONSTRUCTION

Housing	Polycarbonate
Optics	Polycarbonate
Adjustable Angle	N/A
Fixings/Hardware	N/A
Connection Type	N/A
Total Weight	250 g
Dimensions	φ108xH90 mm
Operating Ambient Temp.	-20 to 45°C
Electrical Classification	Class II

# ARCHI

ARC165

ARCHI multi-function  
fixed style downlight.

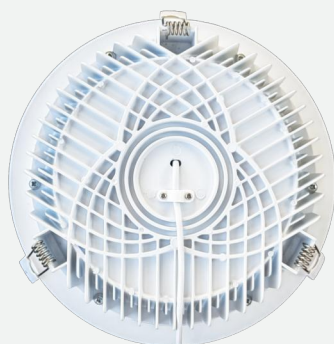

A low maintenance solution that is Ideal for residential apartments, foyers, retail, restaurants and clubs where an energy efficient

and reliable lamp performance is essential.

Optional

Triac/DALI/0-10V Dimming



CCT-Select

Photometric  
Diagram

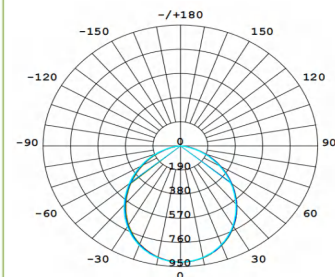

Unit: cd  
 CO/180 99.6deg  
 C90/270 100.2deg

## KEY INFORMATION

Lumen Output	2000 lm
Input Power	20W
Hole Cutout Size	165mm
Install	Recessed
Dimming Options	Triac/DALI/0-10V DIMMABLE
Fitting Colour	WHITE
Warranty	5 yr
IP Rating	IP44
Ik Rating	N/A
IC Rating	IC-4

## PHOTOMETRIC

Efficacy	100 lm/W
LED	SMD
CCT	3000/4000/5000K(CCT-select)
CRI	>80
Beam Angle	100°

## ELECTRICAL

Driver	External
Supply Input	200-240V,50/60Hz
Power Factor	>0.95
Useful life @Ta 25°(L70)	50,000hrs
Emergency time	N/A
Sensor	N/A

## CONSTRUCTION

Housing	Diecasting Alumnium
Optics	Polycarbonate
Adjustable Angle	N/A
Fixings/Hardware	N/A
Connection Type	N/A
Total Weight	900 g
Dimensions	φ190xH45mm
Operating Ambient Temp.	-20 to 45°C
Electrical Classification	Class II

# ARCHI

ARC200

ARCHI multi-function fixed style downlight.

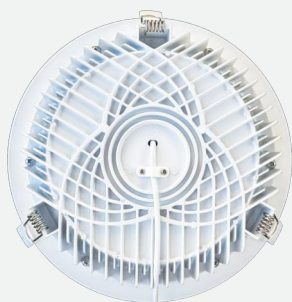

A low maintenance solution that is Ideal for residential apartments, foyers, retail, restaurants and clubs where an energy efficient and reliable lamp performance is essential.

Optional

Triac/DALI/0-10V Dimming



CCT-Select

Photometric Diagram

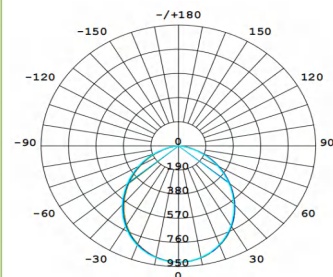

Unit: cd  
 CO/180 99.6deg  
 C90/270 100.2deg

## KEY INFORMATION

Lumen Output	2500 lm
Input Power	25W
Hole Cutout Size	200mm
Install	Recessed
Dimming Options	Triac/DALI/0-10V DIMMABLE
Fitting Colour	WHITE
Warranty	5 yr
IP Rating	IP44
Ik Rating	N/A
IC Rating	IC-4

## PHOTOMETRIC

Efficacy	100 lm/W
LED	SMD
CCT	3000/4000/5000K(CCT-select)
CRI	>80
Beam Angle	100°

## ELECTRICAL

Driver	External
Supply Input	200-240V,50/60Hz
Power Factor	>0.95
Useful life @Ta 25°(L70)	50,000hrs
Emergency time	N/A
Sensor	N/A

## CONSTRUCTION

Housing	Diecasting Alumnium
Optics	Polycarbonate
Adjustable Angle	N/A
Fixings/Hardware	N/A
Connection Type	N/A
Total Weight	1200 g
Dimensions	φ228xH45mm
Operating Ambient Temp.	-20 to 45°C
Electrical Classification	Class II



## Vivid

Vid250

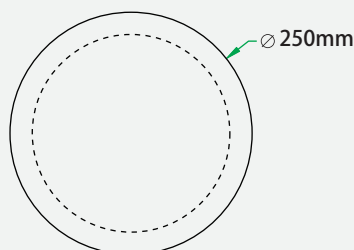

A slimline quick installation ceiling light with improved efficacy and output.

Vivid comes with quick fit mounting bracket, integral control gear and offers discrete appearance for residential, commercial and retail applications. Colour temperature can be set at 3000K, 4000K or 5000K with switch located on the back of the fitting.

Optional:  
DALI/0-10V Dimming



CCT-Select

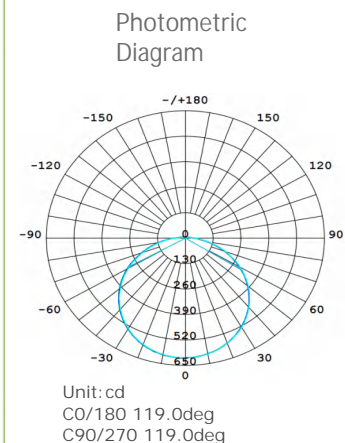

### KEY INFORMATION

Lumen Output	1,440 lm
Input Power	12W
Hole Cutout Size	N/A
Install	Surface Mount
Dimming Options	NON-DIMMABLE/DALI/0-10V DIMMABLE
Fitting Colour	WHITE
Warranty	5 yr
IP Rating	IP44
Ik Rating	N/A
IC Rating	N/A

### PHOTOMETRIC

Efficacy	120 lm/W
LED	SMD
CCT	3000/4000/5000K(CCT-select)
CRI	>80
Beam Angle	120°

### ELECTRICAL

Driver	Integral
Supply Input	200-240V,50/60Hz
Power Factor	>0.95
Useful life @Ta 25°(L70)	50,000hrs
Emergency time	N/A
Sensor	Microwave(Sensor optional)

### CONSTRUCTION

Housing	Polycarbonate
Optics	Polycarbonate
Adjustable Angle	N/A
Fixings/Hardware	Mounting plate
Connection Type	N/A
Total Weight	450 g
Dimensions	φ250xH60mm
Operating Ambient Temp.	-20 to 45°C
Electrical Classification	Class 1

## Vivid

Vid300

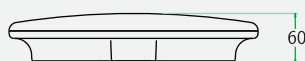
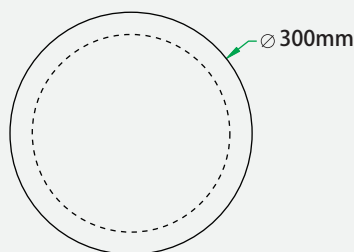

A slimline quick installation ceiling light with improved efficacy and output.

Vivid comes with quick fit mounting bracket, integral control gear and offers discrete appearance for residential, commercial and retail applications. Colour temperature can be set at 3000K, 4000K or 5000K with switch located on the back of the fitting.

Optional:  
DALI/0-10V Dimming



CCT-Select

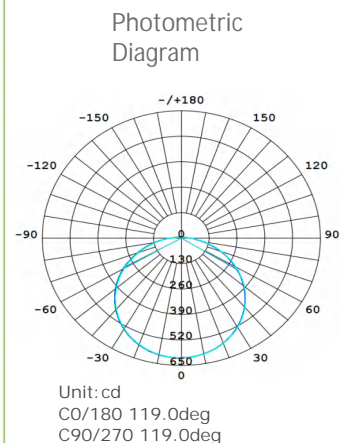

### KEY INFORMATION

Lumen Output	2,160 lm
Input Power	18W
Hole Cutout Size	N/A
Install	Surface Mount
Dimming Options	NON-DIMMABLE/DALI/0-10V DIMMABLE
Fitting Colour	WHITE
Warranty	5 yr
IP Rating	IP44
Ik Rating	N/A
IC Rating	N/A

### PHOTOMETRIC

Efficacy	120 lm/W
LED	SMD
CCT	3000/4000/5000K(CCT-select)
CRI	>80
Beam Angle	120°

### ELECTRICAL

Driver	Integral
Supply Input	200-240V,50/60Hz
Power Factor	>0.95
Useful life @Ta 25°(L70)	50,000hrs
Emergency time	N/A
Sensor	Microwave(Sensor optional)

### CONSTRUCTION

Housing	Polycarbonate
Optics	Polycarbonate
Adjustable Angle	N/A
Fixings/Hardware	Mounting plate
Connection Type	N/A
Total Weight	850 g
Dimensions	φ300xH60mm
Operating Ambient Temp.	-20 to 45°C
Electrical Classification	Class 1

## Vivid

Vid380

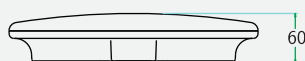
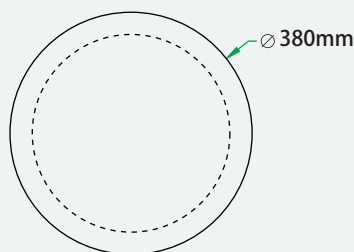

A slimline quick installation ceiling light with improved efficacy and output.

Vivid comes with quick fit mounting bracket, integral control gear and offers discrete appearance for residential, commercial and retail applications. Colour temperature can be set at 3000K, 4000K or 5000K with switch located on the back of the fitting.

Optional:  
DALI/0-10V Dimming



CCT-Select

Photometric Diagram

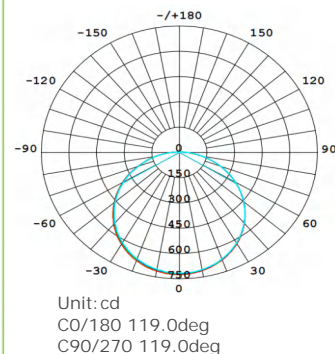

### KEY INFORMATION

Lumen Output	2,880 lm
Input Power	24W
Hole Cutout Size	N/A
Install	Surface Mount
Dimming Options	NON-DIMMABLE/DALI/0-10V DIMMABLE
Fitting Colour	WHITE
Warranty	5 yr
IP Rating	IP44
Ik Rating	N/A
IC Rating	N/A

### PHOTOMETRIC

Efficacy	120 lm/W
LED	SMD
CCT	3000/4000/5000K(CCT-select)
CRI	>80
Beam Angle	120°

### ELECTRICAL

Driver	Integral
Supply Input	200-240V,50/60Hz
Power Factor	>0.95
Useful life @Ta 25°(L70)	50,000hrs
Emergency time	N/A
Sensor	Microwave(Sensor optional)

### CONSTRUCTION

Housing	Polycarbonate
Optics	Polycarbonate
Adjustable Angle	N/A
Fixings/Hardware	Mounting plate
Connection Type	N/A
Total Weight	1.4 KG
Dimensions	φ380xH60mm
Operating Ambient Temp.	-20 to 45°C
Electrical Classification	Class 1

# Uranx

Urx3060

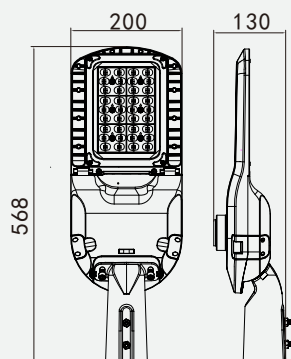

A slimline performance street lantern with improved efficacy and output.

Uranx offers a choice of optics with asymmetrical distribution including an area optic.

Optional Accessories  
 Shorting Cap/PE Cell  
 DALI/0-10V Dimming



Watt-Select  
 CCT-Select

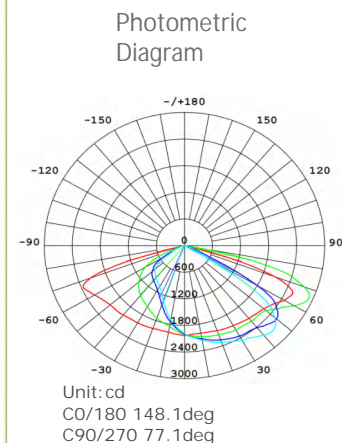

## KEY INFORMATION

Lumen Output	4,500 lm/7800lm
Input Power	30W/60W(Watt-select)
Hole Cutout Size	N/A
Install	N/A
Dimming Options	NON-DIMMABLE/DALI/0-10V DIMMABLE
Fitting Colour	BLACK
Warranty	5 yr
IP Rating	IP66
Ik Rating	IK08
IC Rating	N/A

## PHOTOMETRIC

Efficacy	130-150 lm/W
LED	SMD
CCT	3000/4000/5000K(CCT-select)
CRI	>80
Beam Angle	80°x150°

## ELECTRICAL

Driver	Integral
Supply Input	90-305V,50/60Hz
Power Factor	>0.95
Useful life @Ta 25°(L70)	50,000hrs
Emergency time	N/A
Sensor	PE CELL Available

## CONSTRUCTION

Housing	Aluminium
Optics	Tempered Glass
Adjustable Angle	90°
Fixings/Hardware	Mounting Screws
Connection Type	N/A
Total Weight	4.8 KG
Dimensions	568x200x109mm(No shorting cap)
Operating Ambient Temp.	-20 to 45°C
Electrical Classification	Class 1

# Uranx

Urx100

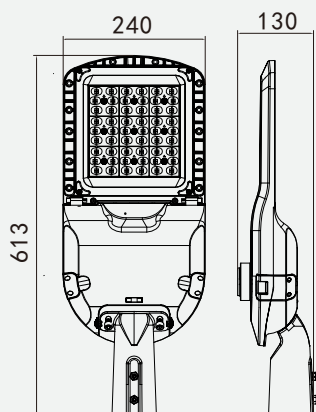

A slimline performance street lantern with improved efficacy and output.

Uranx offers a choice of optics with asymmetrical distribution including an area optic.

Optional Accessories  
 Shorting Cap/PE Cell  
 DALI/0-10V Dimming



CCT-Select

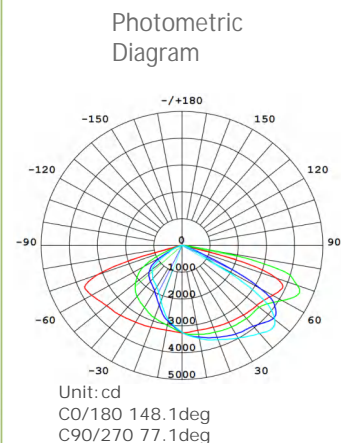

## KEY INFORMATION

Lumen Output	13,000 lm
Input Power	100W
Hole Cutout Size	N/A
Install	N/A
Dimming Options	NON-DIMMABLE/DALI/0-10V DIMMABLE
Fitting Colour	BLACK
Warranty	5 yr
IP Rating	IP66
Ik Rating	IK08
IC Rating	N/A

## PHOTOMETRIC

Efficacy	130 lm/W
LED	SMD
CCT	3000/4000/5000K(CCT-select)
CRI	>80
Beam Angle	80°x150°

## ELECTRICAL

Driver	Integral
Supply Input	90-305V,50/60Hz
Power Factor	>0.95
Useful life @Ta 25°(L70)	50,000hrs
Emergency time	N/A
Sensor	PE CELL Available

## CONSTRUCTION

Housing	Aluminium
Optics	Tempered Glass
Adjustable Angle	90°
Fixings/Hardware	Mounting Screws
Connection Type	N/A
Total Weight	5.2 KG
Dimensions	613x240x109mm(No shorting cap)
Operating Ambient Temp.	-20 to 45°C
Electrical Classification	Class 1

# Uranx

Urx150

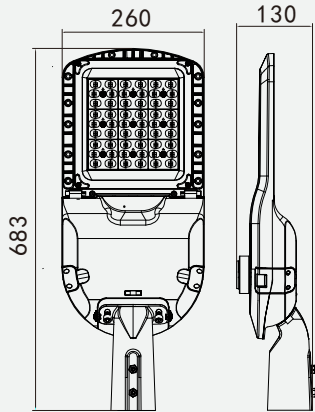

A slimline performance street lantern with improved efficacy and output.

Uranx offers a choice of optics with asymmetrical distribution including an area optic.

Optional Accessories  
 Shorting Cap/PE Cell  
 DALI/0-10V Dimming



CCT-Select

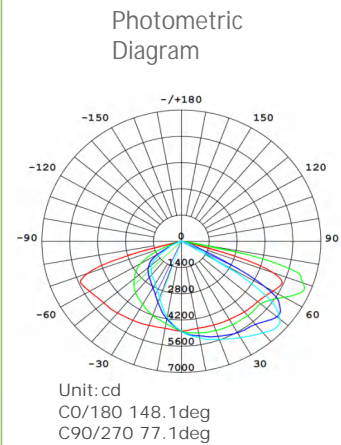

## KEY INFORMATION

Lumen Output	19,500 lm
Input Power	150W
Hole Cutout Size	N/A
Install	N/A
Dimming Options	NON-DIMMABLE/DALI/0-10V DIMMABLE
Fitting Colour	BLACK
Warranty	5 yr
IP Rating	IP66
Ik Rating	IK08
IC Rating	N/A

## PHOTOMETRIC

Efficacy	130 lm/W
LED	SMD
CCT	3000/4000/5000K(CCT-select)
CRI	>80
Beam Angle	80°x150°

## ELECTRICAL

Driver	Integral
Supply Input	90-305V,50/60Hz
Power Factor	>0.95
Useful life @Ta 25°(L70)	50,000hrs
Emergency time	N/A
Sensor	PE CELL Available

## CONSTRUCTION

Housing	Aluminium
Optics	Tempered Glass
Adjustable Angle	90°
Fixings/Hardware	Mounting Screws
Connection Type	N/A
Total Weight	6.1 KG
Dimensions	683x260x109mm(No shorting cap)
Operating Ambient Temp.	-20 to 45°C
Electrical Classification	Class 1

# Uranx

Urx200

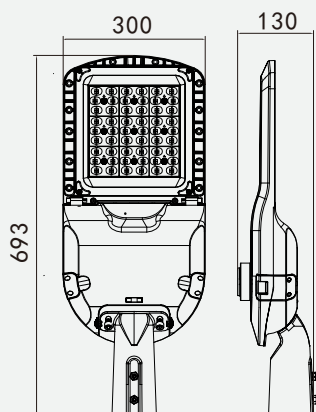

A slimline performance street lantern with improved efficacy and output.

Uranx offers a choice of optics with asymmetrical distribution including an area optic.

Optional Accessories  
 Shorting Cap/PE Cell  
 DALI/0-10V Dimming



CCT-Select

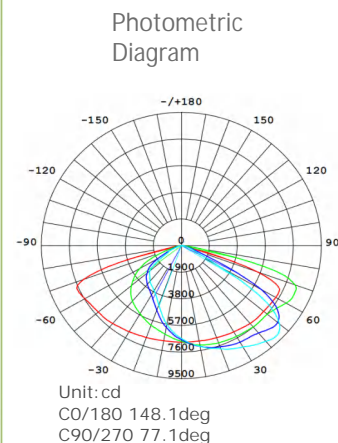

## KEY INFORMATION

Lumen Output	26,000 lm
Input Power	200W
Hole Cutout Size	N/A
Install	N/A
Dimming Options	NON-DIMMABLE/DALI/0-10V DIMMABLE
Fitting Colour	BLACK
Warranty	5 yr
IP Rating	IP66
Ik Rating	IK08
IC Rating	N/A

## PHOTOMETRIC

Efficacy	130 lm/W
LED	SMD
CCT	3000/4000/5000K(CCT-select)
CRI	>80
Beam Angle	80°x150°

## ELECTRICAL

Driver	Integral
Supply Input	90-305V,50/60Hz
Power Factor	>0.95
Useful life @Ta 25°(L70)	50,000hrs
Emergency time	N/A
Sensor	PE CELL Available

## CONSTRUCTION

Housing	Aluminium
Optics	Tempered Glass
Adjustable Angle	90°
Fixings/Hardware	Mounting Screws
Connection Type	N/A
Total Weight	6.7 KG
Dimensions	693x300x109mm(No shorting cap)
Operating Ambient Temp.	-20 to 45°C
Electrical Classification	Class 1

# Uranx

Urx300

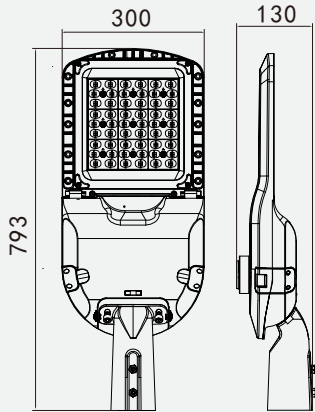

A slimline performance street lantern with improved efficacy and output.

Uranx offers a choice of optics with asymmetrical distribution including an area optic.

Optional Accessories  
 Shorting Cap/PE Cell  
 DALI/0-10V Dimming



CCT-Select

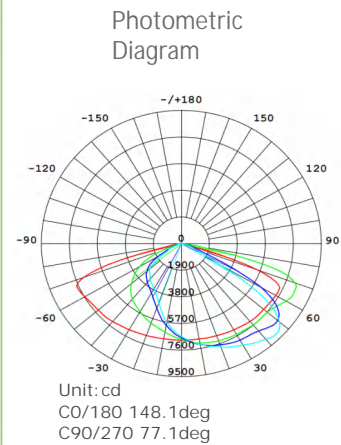

## KEY INFORMATION

Lumen Output	39,000 lm
Input Power	300W
Hole Cutout Size	N/A
Install	N/A
Dimming Options	NON-DIMMABLE/DALI/0-10V DIMMABLE
Fitting Colour	BLACK
Warranty	5 yr
IP Rating	IP66
Ik Rating	IK08
IC Rating	N/A

## PHOTOMETRIC

Efficacy	130 lm/W
LED	SMD
CCT	3000/4000/5000K(CCT-select)
CRI	>80
Beam Angle	80°x150°

## ELECTRICAL

Driver	Integral
Supply Input	90-305V,50/60Hz
Power Factor	>0.95
Useful life @Ta 25°(L70)	50,000hrs
Emergency time	N/A
Sensor	PE CELL Available

## CONSTRUCTION

Housing	Aluminium
Optics	Tempered Glass
Adjustable Angle	90°
Fixings/Hardware	Mounting Screws
Connection Type	N/A
Total Weight	7.9 KG
Dimensions	793x300x109mm(No shorting cap)
Operating Ambient Temp.	-20 to 45°C
Electrical Classification	Class 1



# Uranx Solar

Urx-sl

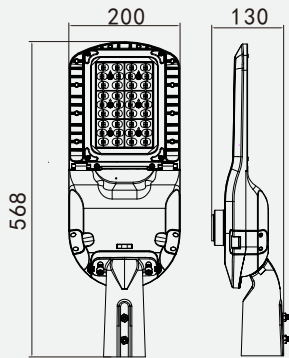

Carefully matched packages of solar panel (with Battery), Light head (with Controller) and Cabling.

Plug-and-play pairing of light head and solar panel unit. Quality componentry matched for reliability of output as a top priority

Optional Accessories  
Spigot 60mm/76mm/89mm

## KEY INFORMATION

- Plug & Play connectivity  
 Rating: IP66  
 Impact Rating: IK10 (Light head), IK08 (Solar Panel)  
 304 stainless steel screws included  
 Accessories: Bird spikes included  
 Spigot Options: Ø60mm/Ø76mm/Ø89mm
- Pre-program: Auto-ON at dusk. Auto-OFF at dawn
  - Built-in infra-red motion sensor regulates light output automatically.
  - Changes from dim mode (30%) to bright mode (100%) upon motion detection.
  - Working time: ≥10hrs bright mode. ≥30 hrs dim mode.

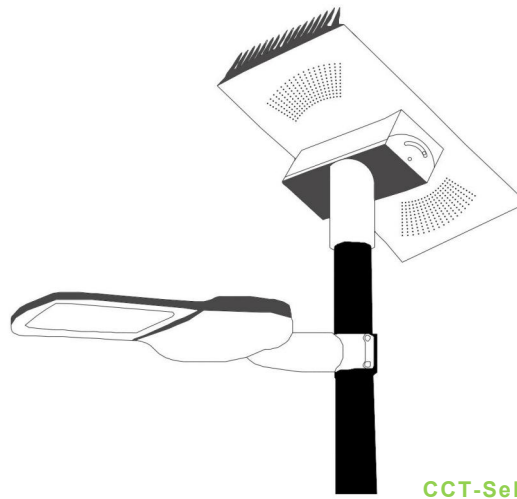

Photometric Diagram

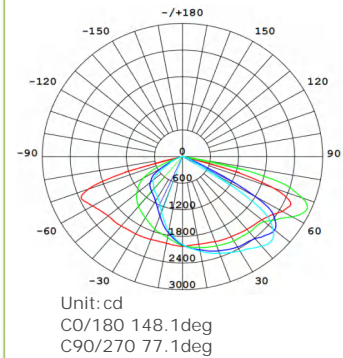

## Single Head Solar Streetlight Kit:

Model : Urx-SL-S

Power:15W

3CCT : 3000K/4000K/5000K Selectable

Optics: T2M Lens

Solar panel:424\*403\*24mm

Solar module:30W,18VDC

Composition:Monocrystalline Silicon PV

Battery:Lithium Iron Phosphate LiFePO4,12Ah / 144Wh

Weight:Panel 7.1kg. Light head 4.5kg



## Double Head Solar Streetlight Kit:

Model : Urx-SL-T

Power:15w+15w

3CCT : 3000K/4000K/5000K Selectable

Optics: T2M Lens

Solar panel:803\*424\*24mm

Solar module: (30W,18VDC) x2

Composition:Monocrystalline Silicon PV

Battery:Lithium Iron Phosphate LiFePO4,12Ah / 144Wh x2

Weight:Light head 4.5kg x2 , Panel 14.8kg



# Skyla

Sky100-L

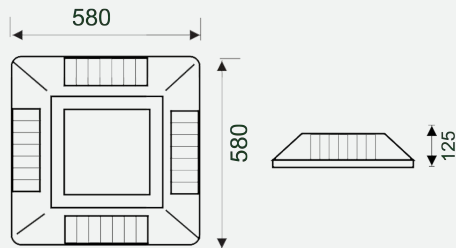

An industrial-grade commercial fixture for ceiling and canopy lighting.

The uniquely designed housing ensures optimum thermal management for the integrated LED module. SKYLA series is easy to install onto a variety of ceiling surfaces and can be used for any industrial or commercial project. Typical applications include carparks, petrol stations, warehouses etc.

### Optional Accessories

Installation plate



Photometric Diagram

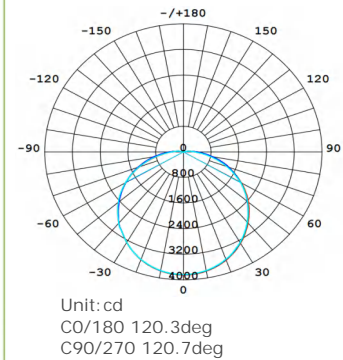

### KEY INFORMATION

Lumen Output	13,000 lm
Input Power	100W
Hole Cutout Size	N/A
Install	N/A
Dimming Options	NON-DIMMABLE
Fitting Colour	White
Warranty	5 yr
IP Rating	IP66
Ik Rating	IK10
IC Rating	N/A

### PHOTOMETRIC

Efficacy	130 lm/W
LED	SMD
CCT	5000K
CRI	>80
Beam Angle	120°

### ELECTRICAL

Driver	Meanwell
Supply Input	90-305V,50/60Hz
Power Factor	>0.95
Useful life @Ta 25°(L70)	50,000hrs
Emergency time	N/A
Sensor	N/A

### CONSTRUCTION

Housing	Aluminium
Optics	Polycarbonate
Adjustable Angle	N/A
Fixings/Hardware	Mounting Screws
Connection Type	N/A
Total Weight	11.3KG
Dimensions	580x580x125mm
Operating Ambient Temp.	-20 to 45°C
Electrical Classification	Class 1

# Skyla

Sky100-S

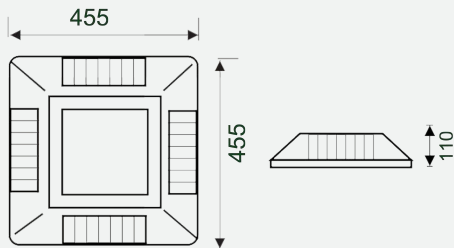

An industrial-grade commercial fixture for ceiling and canopy lighting.

The uniquely designed housing ensures optimum thermal management for the integrated LED module. SKYLA series is easy to install onto a variety of ceiling surfaces and can be used for any industrial or commercial project. Typical applications include carparks, petrol stations, warehouses etc.

## Optional Accessories

Installation plate



Photometric Diagram

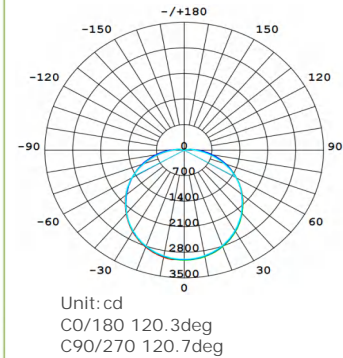

## KEY INFORMATION

Lumen Output	10,000 lm
Input Power	100W
Hole Cutout Size	N/A
Install	N/A
Dimming Options	NON-DIMMABLE
Fitting Colour	White
Warranty	5 yr
IP Rating	IP66
Ik Rating	IK10
IC Rating	N/A

## PHOTOMETRIC

Efficacy	100 lm/W
LED	SMD
CCT	5000K
CRI	>80
Beam Angle	120°

## ELECTRICAL

Driver	Meanwell
Supply Input	90-305V,50/60Hz
Power Factor	>0.95
Useful life @Ta 25°(L70)	50,000hrs
Emergency time	N/A
Sensor	N/A

## CONSTRUCTION

Housing	Aluminium
Optics	Polycarbonate
Adjustable Angle	N/A
Fixings/Hardware	Mounting Screws
Connection Type	N/A
Total Weight	6.7KG
Dimensions	455x455x110mm
Operating Ambient Temp.	-20 to 45°C
Electrical Classification	Class 1

# Skyla

Sky150-L

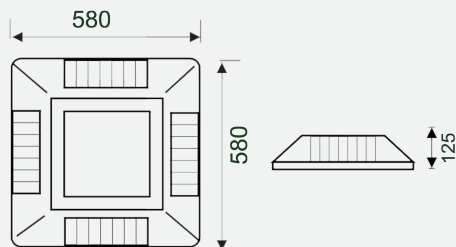

An industrial-grade commercial fixture for ceiling and canopy lighting.

The uniquely designed housing ensures optimum thermal management for the integrated LED module. SKYLA series is easy to install onto a variety of ceiling surfaces and can be used for any industrial or commercial project. Typical applications include carparks, petrol stations, warehouses etc.

## Optional Accessories

Installation plate



Photometric Diagram

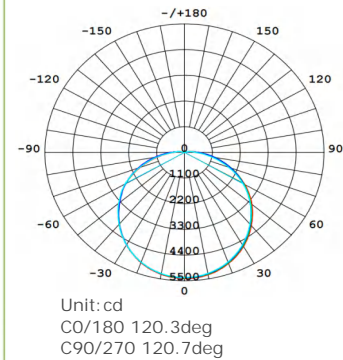

## KEY INFORMATION

Lumen Output	18,000 lm
Input Power	150W
Hole Cutout Size	N/A
Install	N/A
Dimming Options	NON-DIMMABLE
Fitting Colour	White
Warranty	5 yr
IP Rating	IP66
Ik Rating	IK10
IC Rating	N/A

## PHOTOMETRIC

Efficacy	120 lm/W
LED	SMD
CCT	5000K
CRI	>80
Beam Angle	120°

## ELECTRICAL

Driver	Meanwell
Supply Input	90-305V,50/60Hz
Power Factor	>0.95
Useful life @Ta 25°(L70)	50,000hrs
Emergency time	N/A
Sensor	N/A

## CONSTRUCTION

Housing	Aluminium
Optics	Polycarbonate
Adjustable Angle	N/A
Fixings/Hardware	Mounting Screws
Connection Type	N/A
Total Weight	11.3KG
Dimensions	580x580x125mm
Operating Ambient Temp.	-20 to 45°C
Electrical Classification	Class 1

# Skyla

Sky200-L

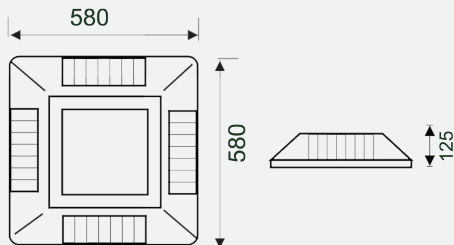

An industrial-grade commercial fixture for ceiling and canopy lighting.

The uniquely designed housing ensures optimum thermal management for the integrated LED module. SKYLA series is easy to install onto a variety of ceiling surfaces and can be used for any industrial or commercial project. Typical applications include carparks, petrol stations, warehouses etc.

## Optional Accessories

Installation plate



Photometric Diagram

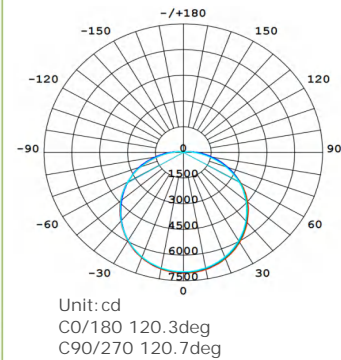

## KEY INFORMATION

Lumen Output	24,000 lm
Input Power	200W
Hole Cutout Size	N/A
Install	N/A
Dimming Options	NON-DIMMABLE
Fitting Colour	White
Warranty	5 yr
IP Rating	IP66
Ik Rating	IK10
IC Rating	N/A

## PHOTOMETRIC

Efficacy	120 lm/W
LED	SMD
CCT	5000K
CRI	>80
Beam Angle	120°

## ELECTRICAL

Driver	Meanwell
Supply Input	90-305V,50/60Hz
Power Factor	>0.95
Useful life @Ta 25°(L70)	50,000hrs
Emergency time	N/A
Sensor	N/A

## CONSTRUCTION

Housing	Aluminium
Optics	Polycarbonate
Adjustable Angle	N/A
Fixings/Hardware	Mounting Screws
Connection Type	N/A
Total Weight	11.3KG
Dimensions	580x580x125mm
Operating Ambient Temp.	-20 to 45°C
Electrical Classification	Class 1

# 60-90mm Pole Clamp

Our outdoor mounting hardware is made from Galvanized Steel and Anti-salt spray powder to prevent oxidation and suit our harsh environment.

Design with grip teeth for extra stability to prevent mast shifting  
Heavy-duty construction

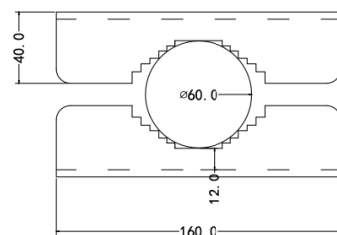
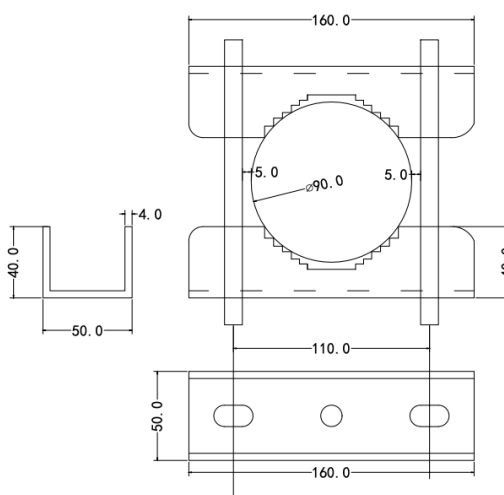
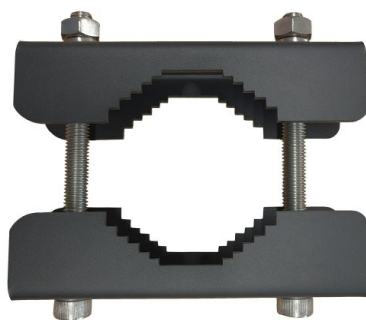

## Pole Adaptor

Our outdoor mounting hardware is made from Galvanized Steel and Anti-salt spray powder to prevent oxidation and suit our harsh environment.

Our customized Pole Adaptor is a convenient solution for reducing the spigot size of a pole or outreach arm.

Finish  
Hot Dip Galvanized

Available in custom sizes to suit the specific needs of your project.

For example:  
Ø80mm > Ø60mm

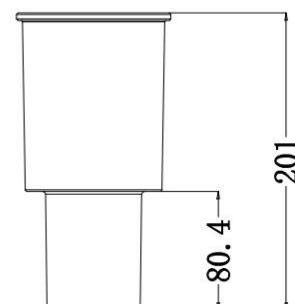
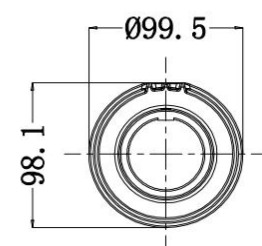
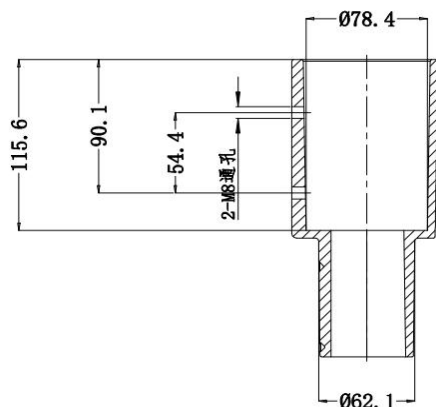

# Pole Mounting Clamp Bracket

Material  
Mild Steel  
Finish  
Anti-Corrosive AkzoNobel  
Powder Coat  
Ingress Protection  
IP66  
Impact Rating  
IK10  
Max. Top Weight  
8.7kg







# Tri-Bracket Floodlight Pole Mast

Material  
Mild Steel  
Finish  
Anti-Corrosive AkzoNobel  
Powder Coat  
Ingress Protection  
IP66  
Impact Rating  
IK10  
Spigot Size  
60mm/76mm/89mm, or  
any customization size  
Max. Top Weight  
26.1kg  
Application  
Steel Light Poles



**lumievo**  
LIGHT EVOLVING

## Dual Mount Floodlight Bracket

Material

Mild Steel

Finish

Anti-Corrosive AkzoNobel

Powder Coat

Ingress Protection

IP66

Impact Rating

IK10

Dimensions

220mm (H) x 250mm (L)

Spigot Size

60mm / 76mm

Max. Top Weight

17.4kg

Application

Steel Light Poles



# Adjustable Pole Mount



Material  
Premium Grade  
Aluminium  
Finish  
Anti-Corrosive AkzoNobel  
Powder Coat  
Ingress Protection  
IP68  
Impact Rating  
IK10  
Spigot Size  
60mm  
Max. Top Weight  
8.7kg



## Floodlight Mount Arm

Use a Floodlight Mount Arm bracket to mount floodlights on walls for signage.

Material

Mild Steel Arm

Finish

Anti-Corrosive AkzoNobel

Powder Coat

Dimensions

500mm/ 800mm/

1000mm

Ingress Protection

IP66

Impact Rating

IK10

Application

Signage

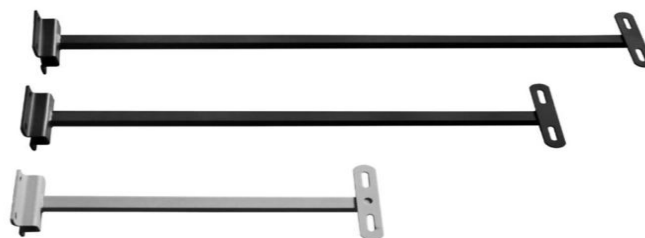
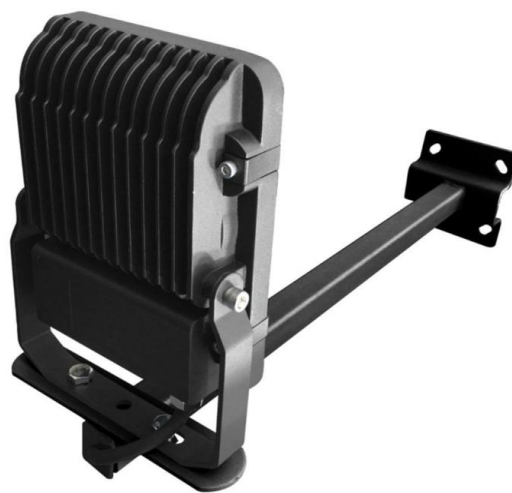

## Flat Mount Streetlight Bracket

Streetlight Brackets are exceptional in terms of strength. This Streetlight Mounting bracket is used for positioning streetlights on buildings and is resistant to extreme weather conditions. Being stylish in appearance and easy to install, it is widely demanded by our clients. We can customize it for any diameter Spigots.

### Material Specifications

Material

Mild Steel

Finish

Hot Dip Galvanised

(Optional Black  
Powdercoat)

Mounting

Pole Mounted at 15° Tilt

Warranty

5 Year Replacement

Benefits

Can be Painted, or  
Powdercoated

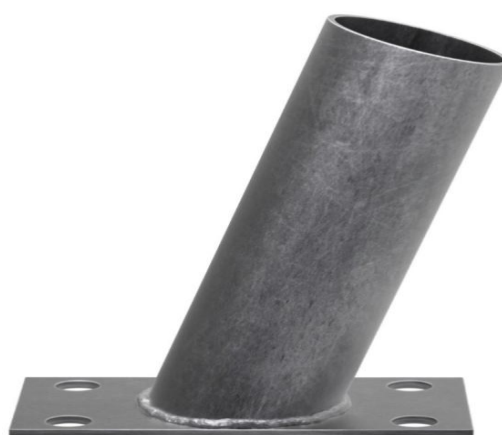

# Explores Possibilities

Shenzhen Lumievo Technology Co.,Ltd  
Building B2, 2nd Ming Jin Hai Industrial Park, Shiyan, Ban An  
District, Shenzhen 518108  
Tel: 0086 139 2655 6020  
Email: [sales@lumievo.com](mailto:sales@lumievo.com)