

Uranx

Urx200

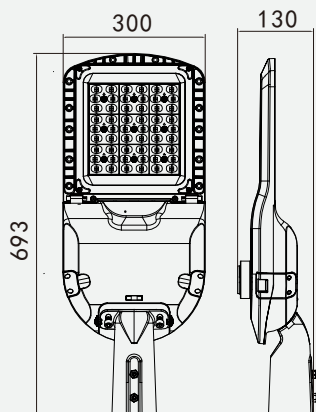

A slimline performance street lantern with improved efficacy and output.

Uranx offers a choice of optics with asymmetrical distribution including an area optic.

Optional Accessories
 Shorting Cap/PE Cell
 DALI/0-10V Dimming



CCT-Select

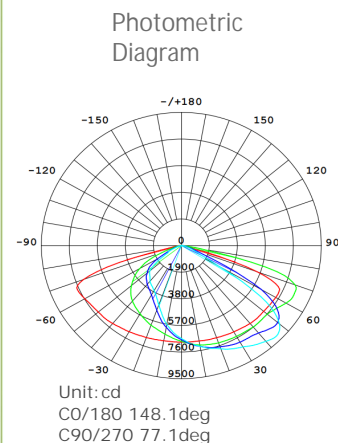

KEY INFORMATION

Lumen Output	26,000 lm
Input Power	200W
Hole Cutout Size	N/A
Install	N/A
Dimming Options	NON-DIMMABLE/DALI/0-10V DIMMABLE
Fitting Colour	BLACK
Warranty	5 yr
IP Rating	IP66
Ik Rating	IK08
IC Rating	N/A

PHOTOMETRIC

Efficacy	130 lm/W
LED	SMD
CCT	3000/4000/5000K(CCT-select)
CRI	>80
Beam Angle	80°x150°

ELECTRICAL

Driver	Integral
Supply Input	90-305V,50/60Hz
Power Factor	>0.95
Useful life @Ta 25°(L70)	50,000hrs
Emergency time	N/A
Sensor	PE CELL Available

CONSTRUCTION

Housing	Aluminium
Optics	Tempered Glass
Adjustable Angle	90°
Fixings/Hardware	Mounting Screws
Connection Type	N/A
Total Weight	6.7 KG
Dimensions	693x300x109mm(No shorting cap)
Operating Ambient Temp.	-20 to 45°C
Electrical Classification	Class 1